

## TABLE OF CONTENTS

<b>INTRODUCTION</b> -----1	Water flow switch instruction -----7
<b>MAIN FUNCTION AND PRODUCT CHARACTERISTICS</b> -----1	Spa cover instruction-----7
<b>IMPORTANT INSTRUCTIONS</b> -----2	Aromatherapy canister instruction (option) -----7
Drainage requirement -----2	Multimedia system instruction (option) -----8
Risk of electric shock -----2	
Temperature -----2	<b>SPA WATER MANAGEMENT&amp; MAINTENANCE</b> -----11
Medical conditions -----2	The effect and adjustment of PH -----11
Soak and cool time -----2	PH adjustment -----11
Alcohol use and medication -----2	Disinfection of the water -----11
Child safety -----2	The application of other special chemical products -----13
Preventing slips -----2	
Electrical appliances -----3	<b>SPA CLEAN AND MAINTENANCE</b> -----13
Weather conditions -----3	SPA surface clean and maintenance -----13
Ventilation -----3	Control panel maintenance -----14
Chemicals -----3	Pillow maintenance -----14
	Spa cover maintenance -----15
<b>SPA INSTALLATION</b> -----3	Skimmer maintenance-----15
Positioning and location of the SPA -----3	Paper filter cleaning -----15
Electrical installation -----4	Pump maintenance (air locks) -----16
	LED lights maintenance -----16
<b>SPA OPERTATION</b> -----4	Aroma canister maintenance (option) -----17
Filling your spa -----4	UV disinfection system maintenance (option) -----18
Draining your spa -----5	Assembly of ladder for the spa (option) -----19
Spa control panel instruction -----6	Assembly of cover lifter for the spa (option)) -----19
Jet instruction -----6	When your SPA is not in use -----21
Air valve instruction -----6	
Water diverter instruction -----6	<b>TROUBLESHOOTING</b> -----22

---

## INTRODUCTION:

- Welcome to your new spa. With the correct preparation and care, your new spa will provide you with many years of fun and relaxation. Please find the “User Manual” and “instruction of control system” in the product attachment.
- This manual has been developed to provide you with the information that you need regarding the preparation, installation, care and operation of your new spa. Please take the time to carefully read the entire manual to ensure that your spa preparations are carried out correctly. Also make sure that you familiarize yourself with the important safety instructions before using your spa.
- If you have any question or doubt on the operation or maintenance of this product, please contact your local dealer.

---

## MAIN FUNCTION AND PRODUCT CHARACTERISTICS:

- **Hydrotherapy function:** The product comes with special hydrotherapy seats which are designed according to ergonomic engineering, different kinds of jets in the seat to help to achieve body therapy. Adjust the massage pressure by adjusting the face, water diverter and air regulator.
- **Air bubble therapy function:** Turn on the air blower, specially designed air jets will blow lots of air bubbles to provide you bubble therapy and fun.
- **Heating function:** SPA comes with heater, once the user set the temperature, the heater will start to maintain the temperature to the set temperature and ensure the spa is available for all season. **Make sure to put the insulation cover on the spa when it is heating.**
- **Filter and circulation function:** SPA comes with filter which can clean the impurities inside efficiently, meanwhile, the system will run the filter cycle programming automatically, to kill the bacteria via the ozone released by the ozone generator.
- **Lighting:** The spa is fitted with an underwater light. The color and mode of the light can be changed via the control system touch panel, helping you create an ambiance to suit your mood.
- **Aromatherapy function (option):** This spa is fitted with an aromatherapy canister which contains scented oil. The soothing scent is dispersed into the water through special plumbing to help you relax.
- **Multimedia (option):** The optional DVD/TV/IPOD allows you to enjoy video or music while exercising in the swim spa or relaxing in the spa.
- **Swimming (swim spa):** Adjust the swim jets to create a powerful current which allows you to enjoy endless swimming without taking up a lot of space.
- **Exercising (swim spa):** With the help of an exercise band or swimming harness, you are able to do all kinds of exercise in swim spa.

**IMPORTANT DECLARATION:** All functions mentioned above are a general introduction to our spas products, The SPA you purchase may be difference. Please check it thoroughly before purchasing. The manufacturer reserves the right to modify and improve the product when necessary without prior notice and without entering into any obligation.

## IMPORTANT INSTRUCTION:

**It is essential to familiarize yourself with general spa pool safety and water treatment procedures. Please make sure to familiarize below contents:**

- **Drainage requirement:** Ensure that the spa is not in a low or floodable position; as this could cause electrical equipment shortage or be dangerous to spa users.
- **Risk of electric shock:** As with all electrical appliances there is a risk of electrocution. The engine room within the cabinet, houses the control unit that operates the spa. The door enclosing the unit should always remain shut. If water happens to enter the engine room, turn the spa off at the power outlet and make sure all the components are dry before attempting to power the spa back up.
- **Temperature:** Keep your spa water temperature no higher than 40°C. Higher water temperatures can cause strain on the cardiovascular system. If the water temperature is higher than 40°C, get out of the spa and contact the dealer as soon as possible. It is recommended that the water temperature be no higher than body temperature i.e. 37.5°C.
- **Medical conditions:**
  - People with diabetes, high blood pressure, heart disease or other cardiovascular conditions should consult their physician before using a SPA.
  - People with open sores or any type of infection should not use the spa.
  - Hot water is an ideal environment for spreading infection, especially if sanitizer levels are not properly maintained.
  - Women who are pregnant should consult their physician before using a spa.
  - To reduce the risk of contaminating spa water and minimize health risks, shower with soap and water prior to using the spa.
- **Soak and cool time:** Limit spa use to no more than 15-20 minutes at a time. Some spa pools are equipped with a cooling seat. When you feel you are getting too hot, sit on the cooling seat and allow your body to cool. When you feel comfortable you may submerge yourself back into the spa pool. Sitting in the spa with your heart above the water level will dramatically decrease the time it takes to cool down. Hyperthermia may be fatal. Do not expose your body to prolonged exposure in water above normal body temperature.
- **Alcohol use and medication:** The consumption of alcohol in and around the spa pool is a hazardous practice. Never use glass drinking vessels near the spa pool. Alcohol can cause drowsiness and lead to drowning. Any person taking medication should consult their physician before entering the spa pool.
- **Child/Handicapped safety:** This appliance is not intend for use by persons (including children) with reduced physical, sensory or mental capabilities, or lack of experience and knowledge, unless they have been given supervision or instruction concerning use of the appliance by a person responsible for their safety. Children should be supervised to ensure that they do not play with the appliance.
- **Preventing slips:** Always take care when entering and exiting a spa due to slippery, uneven surfaces. Handrails and non-slip surfaces will help to minimize the risk of slipping and falling. In some cases steps may be needed to make entering the spa easier.

- **Electrical appliances:** Never have any electrical devices within 2 meters of the spa.
- **Weather conditions:** Do not operate or soak in a SPA during severe weather conditions i.e. thunderstorms, cyclones or electrical storms.
- **Ventilation:** If the SPA pool is not sufficiently ventilated some people may experience throat irritations. Make sure that the SPA pool is properly ventilated if you are installing it in an enclosed area.
- **Chemicals:** Ozone and UV disinfection help reduce the application amount of chemicals in the spa. But SPA chemicals are still necessary to control bacteria, prevent infection and maximize the life of your SPA and its equipment. However, in concentrated form of these chemicals, like other household chemicals, can be hazardous. Always handle and use them with care. Refer to the product's label for safety and handling information. A more in-depth explanation on how to use chemicals in your SPA can be found in the Chemical Management section.

## SPA INSTALLATION:

**Please always find a professional to install your SPA, The manufacturer shall not be responsible for any damage caused by an improper installation or an installation performed by non-qualified personnel.**

### ■ Positioning and location of the SPA:

- Position your Hot Tub in an area that is very well supported and solid enough to take the weight of the tub including the water and the people enjoying the product, you could take advice from a structural engineer or your builder if in any doubt. Ensure that the hot tub is properly supported by either a level concrete pad, or a properly constructed deck capable of supporting 1220kgs /m<sup>2</sup> (250lbs./ft.<sup>2</sup>).
- A concrete base should be at least 4" thick and it not advisable to put your Hot tub on an elevated wooden platform without sound advice, again due to weight issue, the general message is "these things are heavy".
- Avoid placing the SPA where water could flood into the electrical equipment compartment, and also protect the unit from direct contact with very damp areas.
- It is recommended to place the SPA away from trees, as falling leaves may block the filter.
- Your spa needs to be positioned so that the spa's equipment is easily accessible. The equipment is located (in most cases) at the front of the SPA and will need to be accessible for service and power connection. It is recommended that you have access to all sides allowing at least 1/2 a meter access around all 4 sides of your SPA for future access if required. It will be the owner's responsibility to make sure this is completed prior to the service being carried out. All portable SPA equipment must be ventilated. Do not obstruct any vents in the cabinet.

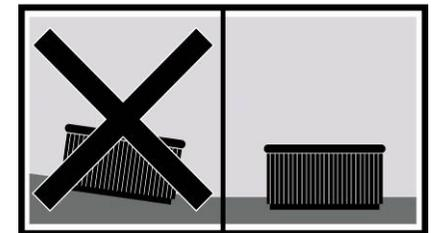

**IMPORTANT NOTE:** DO NOT leave your SPA in direct sunlight for extended periods of time. Doing so may void your warranty. The SPA has covered insulation foam over the shell and pipe work. If left exposed to direct sunlight the surface temperature can build up to 200 °C causing damage to your SPA. It is suggested that you not only have the hard cover over your SPA while not in use but also have the SPA in an area which is sheltered from extreme and harsh weather conditions. Leaving the SPA uncovered and exposed may void your warranty on your SPA and its accessories.

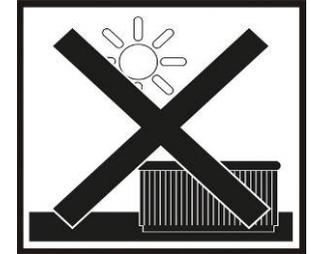

#### ■ Electrical installation (IMPORTANT ATTENTION):

- The power supply should be: 380V/50HZ-60HZ or 220V/50HZ-60HZ. You are advised to apply the 5x6mm<sup>2</sup> cable for 380V power or the 3x10mm<sup>2</sup> cable for 220V power.
- The electrical supply to your new spa will require a dedicated circuit with no other appliances or sockets sharing the power. Electrical burnout due to incorrect amperage WILL NOT be covered by warranty. Ask for qualified electrician for electrical connection.
- Ensure the main power supply has installed high sensitive leakage protectors. Recommend 30mA leakage protectors.
- Ensure your new SPA is safely earthing as right figure. Please refer the control system instruction manual before electrical installation.
- You are advised to drill a dia. 26mm cable hole on the bottom of one corner skirt that is near the control box as right figure for the cable.



## SPA OPERATION:

In order to avoid any misunderstanding or damage on the spas, please follow below procedure carefully before enjoying your spa.

#### ■ Filling your SPA:

- Before filling your spa, please check and tighten all the live connectors, they may go loose during transportation.
- Please check and make sure all the check valves are all in the open position.
- Check that the drainage valve is shut off.
- Check that all jets are in the open position. Swivel anti-clockwise to turn your jets on.
- Fill your SPA with water. **Make sure to fill the water through filter area every time in order to prevent air block in the pumps.**
- Fill water to the line on the water level indicator as the figure which is 4" to 6" (100 to 150mm) below the top edge of the spa. Do not overfill as the spa's water level will rise as each person enters the spa.



The required water level



**NOTE:** To avoid any damage to the components, DO NOT fill hot water over 40°C into your SPA.

## ■ Draining your SPA:

- If you use your SPA once or twice a week, the need to drain your spa will be less frequent than a SPA owner who uses their SPA three or more times a week. Therefore, it would be recommended that a SPA be drained at least every 3 months.
- There are two kinds of drainage valves as per different spas: the side drain valve is on the skirt panel and the corner drain valve is positioned at one corner of the bottom base.



- Details for drainage are as follows:



1. The Red ball valve (inside cabinet) connected to the black Drain is normal open out of factory.



2. Remove the cap of the drain valve by turning it anti-clockwise.



3. Connect a 3/4 inch hose or screw a standard male hose fitting onto the valve and connect your hose.



4. Turn the valve anti-clockwise to the end and then pull out the valve forward to drain the water.

**NOTE:** Ensure the power is shut off before draining. Equipment damage caused by dry running will not be covered under warranty.

**DISPOSAL OF WATER:** Do not drain water onto your lawn or plants unless all of the bromine or chlorine has dissipated from the water. The sanitizer in your water will dissipate quickly by leaving the cover off and exposing the water to direct sunlight.

- **SPA control panel instruction:** Refer to “Control Panel Operation Guide” together with the product.

- **Jets instruction:** Jets are the main parts in which massage comes into effect. Almost all of the jets in your spa are adjustable. You can adjust the water flow through by rotating the jet face.

- Turn the jet face clockwise about 1/4 of a turn, the jets are turned on.
- Turn the jet face anti-clockwise about 1/4 of a turn, the jets are turned off.



**NOTE:** Some jets and the air jets are unadjustable. Don't rotate these jets with force. It may cause damages to the jets.

- **Air valve instruction:** There are three styles of air valve as per the requirement of dealers. Your spa may have one of the air valves in below figure. Air controls affect the pressure of your jets by adding air. You may have more than one air valve on your spa, each of which will be associated to a certain group of jets. By opening an air valve when the pump is on, air will be drawn into the water flow to increase the massage strength.

- When the air valve is turned clockwise, it will decrease the power of the massage jets.
- When it is turned anti-clockwise, it will increase the power of the massage jets.

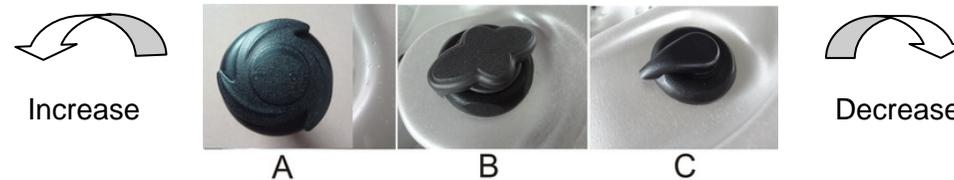

**NOTE:** For better heating efficiency, please turn the air valves off. The air may cool the spa water temperature.

- **Water diverter instruction:** Your spa may be equipped on one of the below water diverters. Rotating the water diverter, you will divert the massage power of different seats.



- Water flow switch instruction:** The water flow switch controls the flow of water to the options, such as waterfalls and fountains. Rotating the water flow switch will turn on, turn off and adjust the water flow.



**NOTE:** For better heating efficiency, turn the water flow controls off when the spa is not in use.

- Spa cover instruction:** There is one coded lock on each corner of the insulation cover. Please fix the male part of the lock on the spa corner panel with 3x15mm round head screws. Set the password to 0-0 and then press the two buckles on the sides to open the coded lock.

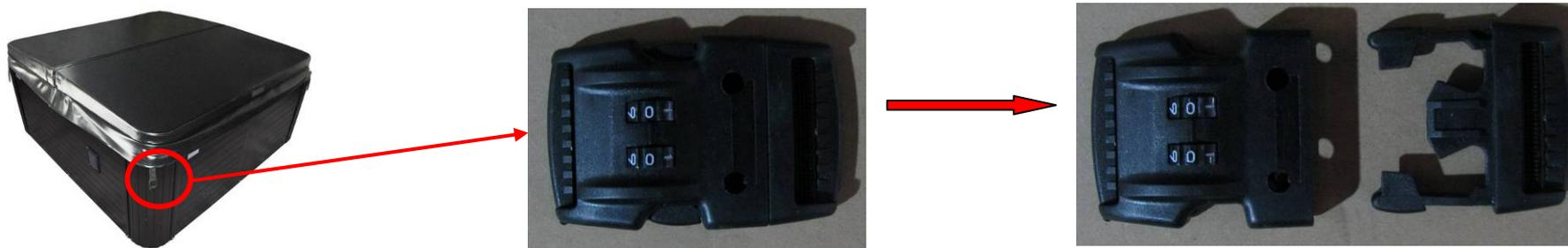

**NOTE:** Please put the cover on the spa when the spa is heating and after use. Remember to lock the cover to preventing the children from entering into the spa without adult's care.

- Aroma canister instruction (option):** The Aroma canister is the part that brings aromatherapy. The aroma canister is connected to the air blower of the spa and is composed by aroma canister cover, aroma canister and canister holder. Turn the canister knob clockwise to open and increase the aromatherapy; turn the canister knob anti-clockwise to decrease and close the aromatherapy.

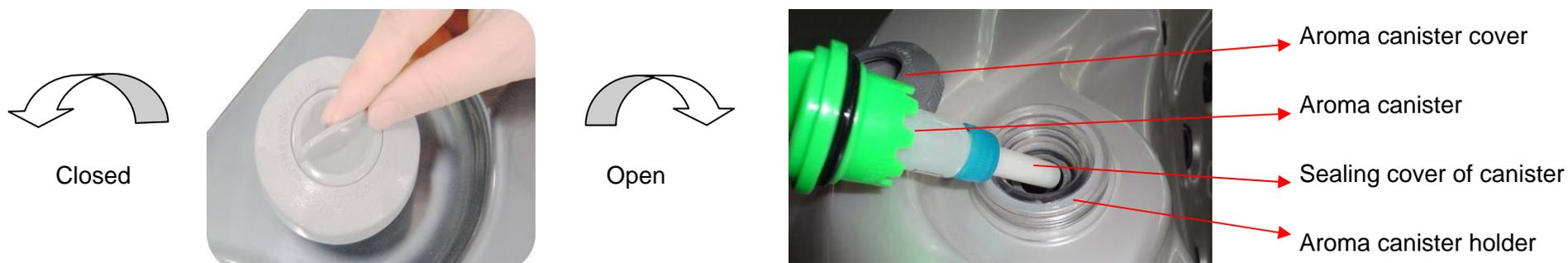
**NOTE:**

◆ Make sure to remove the sealing cover of aroma canister before first use. For detail, refer to the instruction of aroma canister maintenance (on page 17).

◆ To help aromatherapy oils last longer, remember to turn the aromatherapy canister off when the spa is not in use.

■ **Multimedia system instruction (option):** The spa may obligate to connect with pop-up LCD TV, DVD/CD/MP3 player, IPOD/IPHONE dock, pop up speakers and other multimedia systems. Please check which multimedia system you have for your SPA before using.

➤ **Pop-up TV:** There is a small control panel to control the up and down of the TV near the main control panel. Press "UP" to make the TV up, press "DOWN" to make the TV down, press "STOP" to make the TV stops moving. Please refer to the manual of TV for detailed operation of the LCD TV.



**NOTE:** The remote control of TV is waterproof. But DO NOT put the remote control of TV into the water for a long time to increase its service life.

- **CAR DVD player with waterproof box:** This DVD player is not waterproof. It must be equipped together with a waterproof box. For the first use of the DVD player, **make sure to open the skirt panel and take out the two fixing screws on the top of DVD player.** If not, you can not put the disks into the player. Please refer to the user manual of DVD player for detailed operation together with the spa.



**NOTE:** Close the cover of the waterproof box of DVD player after using. The remote control of DVD is waterproof. But DO NOT put it TV into the water for a long time to increase its service life.

- **Waterproof DVD player:** This DVD player is waterproof which can be exposed on the spa cabinet directly. Please refer to the user manual of DVD player for detailed operation together with the spa.



**NOTE:** Close the front cover of the DVD player downwards after using. The remote control of DVD is waterproof. But DO NOT put it TV into the water for a long time to increase its service life.

- **IPOD/IPHONE dock:** Please refer to the user manual of IPOD/IPHONE dock for detailed operation.



**NOTE:** Close the cover of the IPOD/IPHONE dock towards the right after using. The remote control of DVD is waterproof. But DO NOT put it TV into the water for a long time to increase its service life.

- **Pop up speakers:** There are two styles of pop-up speakers for different spas-oval one and round one. Press the speakers downwards from the top to make it pop up or closing.



**NOTE:** Close the speakers downwards after using. Prevent the speakers from touching water if possible.

## SPA WATER MANAGEMENT & MAINTENANCE:

- Please note that these instructions are just a guide to maintain the spa's water quality. Before any actions, please consult your local SPA specialist for proper amount of sanitizer use, and take proper action depending on the capacity of the SPA.
- You should never use pool grade chemicals in your spa. Any damage to equipment caused by using pool grade chemicals or other improper chemicals will not be covered under warranty.
- Spa water should be professionally tested at least once a month. It's recommended that the water is tested weekly by the end user. When adding chemicals to the spa, make sure the pumps are running and allow 20-30 minutes for the chemicals to mix. Test the water after the chemicals are sufficiently mixed into the water.

**NOTE:** Do not cover the SPA for at least 30 minutes after adding chemicals.

- **The effect of PH:** Low pH (below 7.2) causes sanitizers to dissipate more rapidly, increases corrosion of surfaces and equipment, and may make water irritating to spa users. If pH is high (above 7.6) chlorinating sanitizers are less effective, surfaces and equipment can scale, water may cloud and shorter filters runs may occur.

**ATTENTION:** The pH level measures the acidity and alkalinity: Values above 7 are alkali and below 7, are acid. A PH index of between 7.2 and 7.6 is recommended.

**WARNING:** Please make sure that the correct PH level is maintained, any damage caused by an inadequate PH level is not covered by your Spa guarantee.

- **PH adjustment:** Check the pH of the Spa water daily using the pH tester. (Not supplied).
  - If the pH is above the above-mentioned indexes, do not enter the SPA temporarily. Wait for two hours and re-do the pH test.
  - If the pH is below the above-mentioned indexes, let the pumps prime. Wait for two hours and re-do the pH test.
  - If the proper pH level can not be maintained by the above instructions, please add appropriate amount of acidity-alkalinity balance reagent into the water, uncover the spa cover, leave it mix in for 20 minutes, then re-do the pH test;
- **Disinfection of the water:** Disinfection of the water is of utmost importance in order to destroy algae, bacteria and organisms that could develop in the water. However, excessive disinfection could cause skin and eye irritation.
  - **Bromide tablets:** Are a suitable disinfectant for the Spa water. This product is placed in the pre-filter and gradually dissolves. Check the residual bromide level daily using the Br analyzer set. The recommended level of residual bromide is between 2.2 and 3.3 ppm.

- **Ozone disinfection:** Ozone or O<sub>3</sub>, is an oxidizing chemical compound, which is very effective for disinfecting water. The main advantage of ozone is that it leaves no chemical trace and is odorless. Generally the spa is equipped with one ozone generator which produces 50mg ozone per hour. Ozone disinfection is an automatic process and resulting ozone is injected into the water through the ozone injector, ozone mixer and coming out from the ozone jet (**it is one of the four black circulation jets at the bottom of the tub, you can see there are air bubbles coming out from it in the water**). The ozone generator works automatically once the circulation pump is running. The indicator light of ozone generator will be on when it is working. You can open the skirt panel to check it.



**NOTE:** You are advised to replace the ozone generator every two years to get better disinfection effect.

- **UV disinfection:** Ultraviolet disinfection can sterilize water in an effective and efficient way. Ultraviolet energy can destroy bacteria and virus in about 1-5 seconds. In order to reach the same disinfection effect, it costs the other chemicals methods (Chlorine, Chlorine dioxide, ozone) about 30 minutes or more contact time. Besides, UV disinfection is a physical process. During the disinfection process, it doesn't produce any byproduct and there is no abnormal flavor in the water after treatment. The UV system works automatically once the circulation pump is running. There are two indicator lights on the power box of UV system. The green light on means it works correctly; the red light on means there is problem with it.



**NOTE:** The lifetime of an UV lamp is approximate one year. You are advised to replace the UV lamp every year to get better disinfection effect.

- **The application of other special chemical products:** Besides the pH adjustment and the above-mentioned disinfection ways, there are some cleaning products which can be used in spa water.
  - **ANTI-CALCAREOUS:** it can be used to prevent/reduce precipitation of calcium salts (scale), especially in hard water areas. Use it once a week and whenever the water is renewed.
  - **SPA ALGAECIDE:** Prevent algae from growing in the water, use it once a week and whenever the water is renewed.
  - **ANTIFOAM:** Prevent precipitation of calcium salts (scale), use it once a week and whenever the water is renewed.

**WARNING:**

- ◆ Add the exact amounts to the water, as specified. Do not mix products, to avoid possible reactions.
- ◆ Do not smoke while handling these products - they may be flammable.
- ◆ Do not add chemical products to the water if there is someone in the spa.
- ◆ Keep containers tightly closed in dry, well-ventilated places, and keep these products away from children.
- ◆ Do not inhale chemical products, and take care not to let them come into contact with the eyes, nose or mouth. Wash hands after use.
- ◆ Follow the emergency instructions on the product label in the event of an accident or ingestion.

**SPA CLEAN AND MAINTENANCE:**

Owning a spa is fun, relaxing and therapeutic, but more importantly we must look after our investment to keep it healthy and economical, thus avoiding unnecessary premature repair costs. Detail below is a simple step by step procedure to follow.

- **SPA surface clean and maintenance:** The spa surface is made of high-glossy acrylic and must be kept clean. You are suggested to clean the spa outside water line once a week and clean the whole spa after drain. Details steps as below:
  - Clean the dirt with wet towel, we can use the neutral detergent and soft towel, can not use the detergent which with ketone or chlorine water.
  - If the surface has some light scratch, please polish it with 2000# sand paper and then make up it with toothpaste, re-polish it with soft towel.
  - Please do not clean the spa surface with any chemical solution or crude tools; do not scratch the spa surface with hard material or knife.
  - Please do not clean the spa surface with nail polish, nail polish remover, dry detergent, acetone, paint remover etc. It will damage the surface.
  - Do not touch the spa surface with any heat source over 70°C.

- **Control panel maintenance:** the control panel is glued on the tub shell by silicon sealant. If you need to replace it, use a blade to take it out from the shell. In daily use, do it as follows:
  - Do not touch the control panel with hard objects to avoid scratching.
  - Avoid prolonged direct sunshine on the control panel.
  - Keep the control panel covered when not in use.
  
- **Pillow maintenance:** Your spa may be installed one of the two kinds of pillow as below. You can remove the pillows for cleaning and maintenance quickly and easily.
  - **Fixed pillow:** Grab the lower edge of the pillow with both hands firmly and pull up. As you do this, the pillow inserts will pop out of the holes. Reseat the pillows by aligning the pillow inserts with the holes and striking the pillow hard enough to insert the pegs back into the holes.

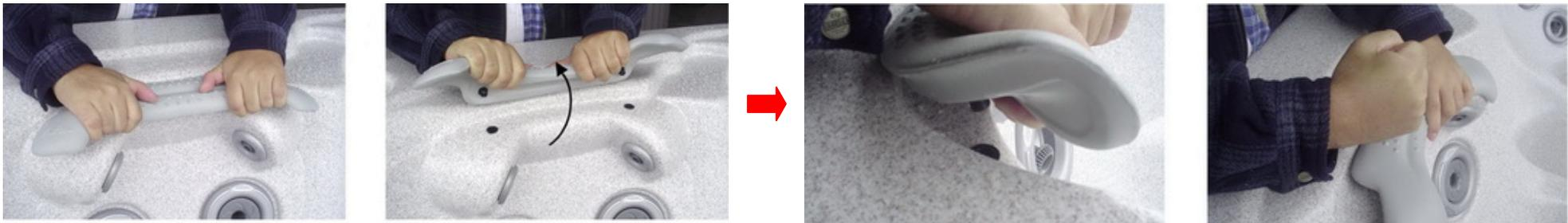

- **Adjustable pillow:** Grab the pillow and pull it upwards to lift the pillow. Lower the pillow by pressing the button on the bottom.

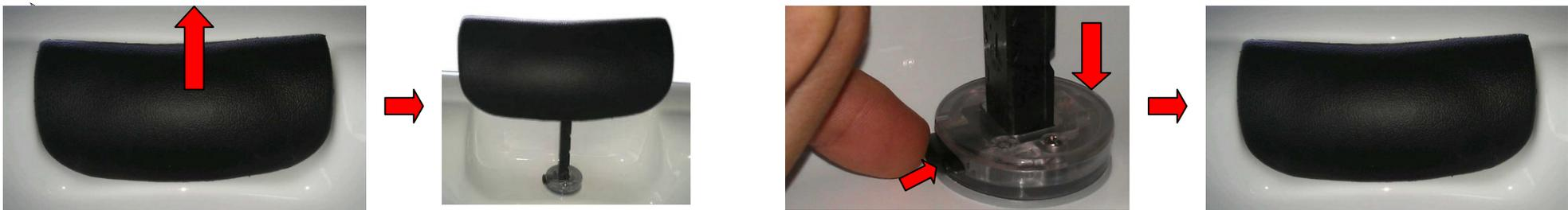
**NOTE:**

- ◆ Clean the pillow with neutral detergent;
- ◆ Excessive chemical levels and ozone may cause fading of headrests. Fading is not covered by warranty.

### ■ SPA cover maintenance:

- Clean the cover with soapy water. Make sure do not let the soap water go inside the spa.
- Do not pull off the cover by catching the linker in the middle of the cover. It is easy to be broken.
- Do not seating, lie and jump on the cover. Damage caused from this is not covered by warranty.

**NOTE:** Please put the cover on the spa after use or clean . Leaving the spa uncovered and exposed may void the warranty on your spa and its accessories.

### ■ Skimmer maintenance: There are two styles of skimmer on different spa-lifting skimmer and wall-mounting skimmer.

- How to remove the paper filter from the lifting skimmer:



1. Swivel the protection grating anticlockwise.



2. Take out the protection grating upwards.



3. Take out the lifting cartridge upwards.



4. Swivel the paper filter anticlockwise.



5. Take out the paper filter upwards.

- How to remove the paper filter from the wall-mounting skimmer:



1. Unscrew the fixing screw anticlockwise.



2. Take out the protection grating upwards.



3. Pull out the filter screen towards.



4. Swivel the paper filter anticlockwise.

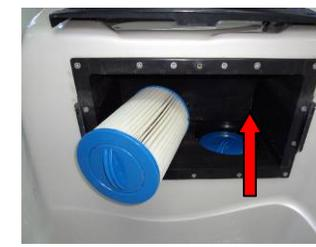

5. Take out the paper filter upwards.

- **Paper filter cleaning:** You should clean your paper filters regularly. Remove your filters and spray the debris out of it with a high pressure hose once a week. Soak your filters in a cartridge filter cleaning solution and then spray it with a high pressure hose once a month.

- Cut off the power of the spa.
- Remove the paper filter by turning it counter clockwise (please check the skimmer instruction before doing it).
- Clean the paper filter by spraying water from top to bottom at a 45° angle as the right figure to remove debris.

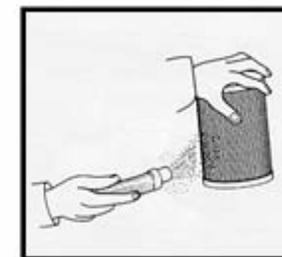

**NOTE:** Contact your dealer to replace the old paper filter every 3-6 months.

**WARNING:** Always ensure that the power to your spa is off before removing the paper filters. Something may be sucked into the circulation pump or heater and cause failure. This fault will not be covered by warranty.

- **Pump maintenance (air locks):** If you have emptied and refilled your spa and the pump comes on but there is no water movement in your spa, the spa is probably suffering from an air lock. This situation is more often for circulation pump than other massage pumps. To get the air out of your pump, turn the spa off and find the circulation pump, which is situated inside the spa cabinet. Locate the pipe which goes into the top of the pump. This has a large nut, which is called the barrel union. Undo anti-clockwise until you hear the air escape. When the water comes out, re-tighten. This should fix the airlock. Sometimes you have to start the pump again to remove the air.

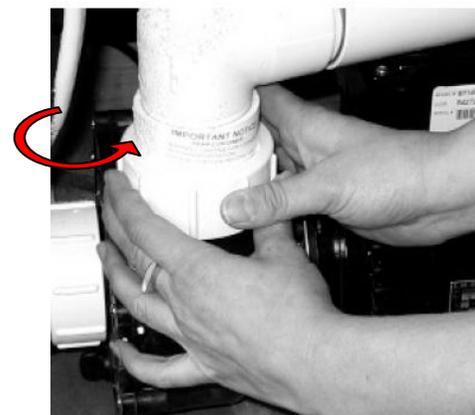

**NOTE:** to prevent this from happening, always fill the spa through the filter box.

- **LED lights maintenance:** Your spa will be equipped with one kind of LED lights as below. If the LED lights can not be on or its color is different from other lights, you need to replace it. Please follow below steps to replace the LED lights.
  - **How to replace the plug-in style LED lights:** pull out the defective LED light from its holder on the tub shell and the white socket. And then insert the new light to the holder and socket accordingly.



- **How to replace the buckle style LED lights:** pull out the defective LED light from its holder on the tub shell and swivel the black buckle anti-clockwise. And then put the new light to the holder and buckle accordingly.

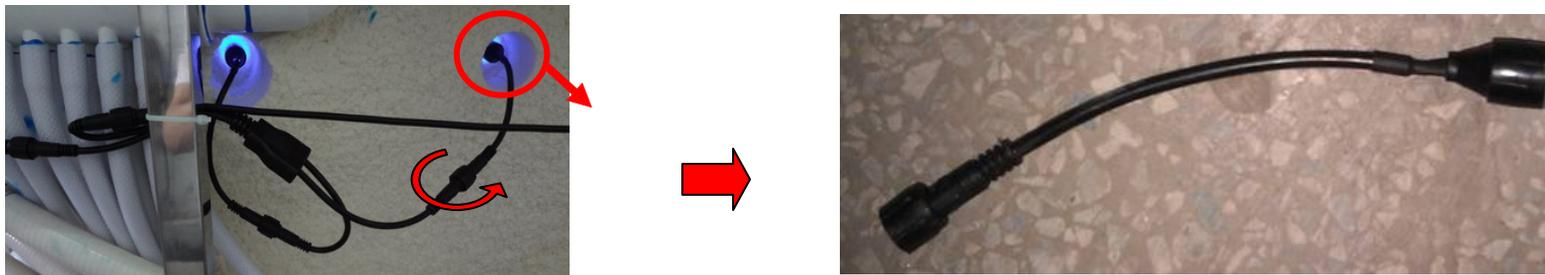

- **Arroma canister maintenance (option):** Replace the lasting scents essential oil in 2 or 3 months time accordingly. Turn the canister cover (part A) anti-clockwise to open it (fig. ①). Turn the canister knob (part B) anti-clockwise to take it out (fig. ②). Check if it is any lasting scents essential oil left. Replace it when it is empty. Remember to remove the sealing cover (part D) of aroma canister before putting it into the holder (fig. ③④⑤⑥). You can contact the local dealer to get a new one for replacement.

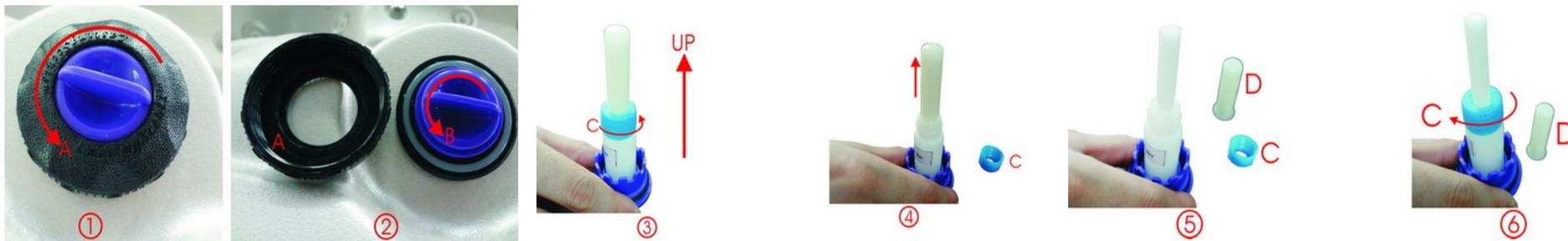

**NOTE:** Make sure to turn off the air blower firstly before opening the aroma canister cover.

- **UV disinfection system maintenance (option):** It is mandatory that the UV lamp (part ④) is replaced and the quartz thimble (part ⑥) is cleaned every 12 months to maintain optimum performance.

- Waterproof strainer-①
- Big aluminum nut-②
- Lamp socket and lead wire-③
- UV lamp-④
- Rubber O-ring-⑤

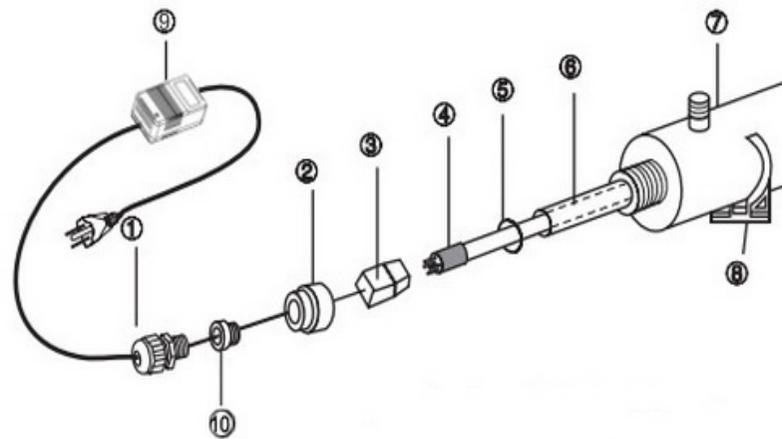

- ⑥- Quartz sleeve
- ⑦- Stainless steel Chamber
- ⑧- Clip
- ⑨- Ballast
- ⑩- small aluminum nut

- **How to replace the UV lamp:** Loosen the waterproof strainer (part ①) and then swivel the small aluminum nut (part ⑩) anti-clockwise to take the UV lamp out. Pull out the old UV lamp (part ④) from the socket (part ③) and then insert the new one to it and then put it to the chamber (part ⑦) again. Do not loosen the big aluminum nut (part ②) when you replace the UV lamp. If not, the water will come out from the entry of chamber.

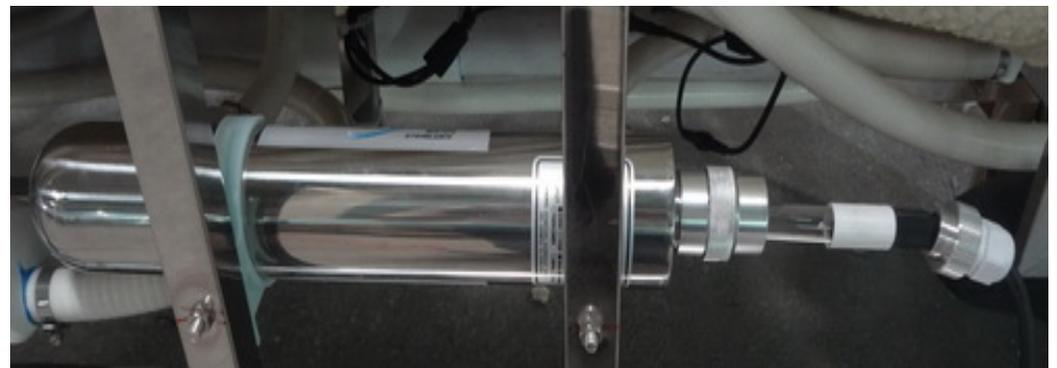

**WARNING:** Germicidal ultraviolet rays are harmful to eyes and skin. Do not open the UV chamber when it is still powered on.

- **How to replace the quartz sleeve:** Before replacing or clearing the quartz sleeve (part ⑥), you are obligated to close the two small ball valves on the inlet and outlet of the chamber. If not, the water will come out from the entry of the chamber.



1. Fix the UV chamber vertically and then insert the quartz sleeve



2. Put the O-ring on the quartz sleeve



3. Slid down the O-ring to the outlet of the chamber



4. Tighten the big aluminum nut to the chamber

- **Assembly of ladder for the spa (option):** The ladder is knocked-down to save the packing space for the container. You need to assemble them as below simply before using.



- **Assembly of cover lifter for the spa (option):** There are two kinds of cover lifters available for the spa. They are all knocked-down for the packing. You need to assemble them before using.

- **How to assemble cabinet-mounting cover lifter:** This cover lifter is fixed on the cabinet. It may damage the panel of cabinet after a few years if you handle the cover roughly.

COVER LIFT

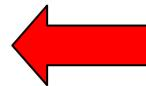
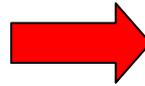
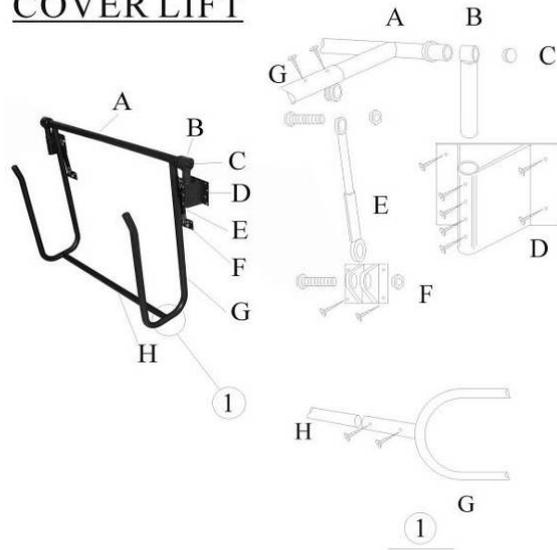

- **How to assemble free-standing cover lifter:** This cover lifter is fixed by inserting the plate under the bottom base of the spa. It is not suitable for round spa.

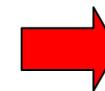
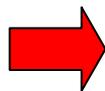
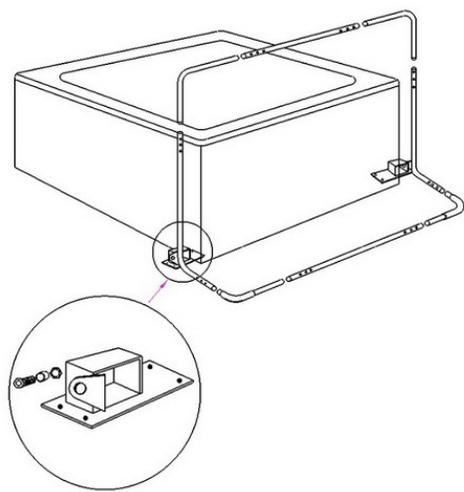

- **When your SPA is not in use:** If you are going away for a period longer than 2 months, it is recommended that you turn your spa off and empty it. It is important to remember to leave the cover on even while empty to protect the shell. If you are going away for a few days or weeks, do not turn your spa off completely. Turn the temperature down to 15 degree, so that the filtration cycles are still functioning but the spa doesn't heat.
  - **3-5 days:** Test PH and sanitizer levels of the spa water and adjust it if necessary (please check the water maintenance for details); cover the spa; test water balance and adjust if necessary before using the spa again.
  - **5-14 days:** Setting the lowest temperature or sleep mode. Adjust the PH and water treating (please check the water maintenance for details); cover the spa cover; adjust the PH and water treating when you reuse the spa.
  - **More than 15 days:** Turn off the power; open the drain valve and drain the spa; remove the paper filter; keep the spa dry and put the spa cover and protection bag on it.

**TROUBLESHOOTINGS:**

Description of trouble	Analysis	Solution
An error message appears on the LCD display	<ul style="list-style-type: none"> <li>● Error detected by digital diagnostics function.</li> </ul>	<ul style="list-style-type: none"> <li>● Please check the error message trouble shooting in the control system manual, and then contact your local dealer if you are unable to resolve the issue.</li> </ul>
SPA can't start in any mode	<ul style="list-style-type: none"> <li>● Power off.</li> <li>● Control panel is locked.</li> <li>● Control panel failure</li> </ul>	<ul style="list-style-type: none"> <li>● Check the power switch on or leakage switch is turned on.</li> <li>● Check the control panel is unlocked.</li> <li>● Check the failure code in control system manual for solution, and then contact your dealer to do the maintenance.</li> </ul>
SPA starts automatically	<ul style="list-style-type: none"> <li>● Filtration program is operating.</li> <li>● Heating function is operating.</li> <li>● Anti-freezing function is operating.</li> </ul>	<ul style="list-style-type: none"> <li>● The control system will automatically stop when the program finishes.</li> </ul>
The water pump turns off	<ul style="list-style-type: none"> <li>● The pump running time is more than the system default maximum running time.</li> <li>● The pump motor is overheating protected.</li> </ul>	<ul style="list-style-type: none"> <li>● Repress pump button to restart the pump.</li> <li>● Stop running pump more than 1 hour until cool and then start the pump.</li> </ul>
Pump running after filling spa but no water coming through jets	<ul style="list-style-type: none"> <li>● The jets are closed.</li> <li>● Air blockage in the water pump.</li> </ul>	<ul style="list-style-type: none"> <li>● Check whether the jets are closed. If yes, open it.</li> <li>● Turn pumps on and off several times to drain the blocked air. Unscrew the live union on the water pump to release the air and then screw on tightly.</li> </ul>
Heater heating slowly or failing to heat	<ul style="list-style-type: none"> <li>● Temperature setting is low</li> <li>● Filter cartridge dirty and blocked</li> <li>● No spa cover on the spa causing heat loss</li> <li>● Circulation jets is closed</li> <li>● Heater broken</li> </ul>	<ul style="list-style-type: none"> <li>● Set the temperature up</li> <li>● Clean or replace paper filter core</li> <li>● Put the cover on the spa</li> <li>● Turn on the jets</li> <li>● Contact the local dealer for maintenance</li> </ul>
Weak water flow through the jets	<ul style="list-style-type: none"> <li>● Jets are not fully opened.</li> <li>● Jets are blocked.</li> <li>● Air valve is turned off.</li> <li>● Water diverter closed to the seat.</li> <li>● Water pump ball valve is not fully opened.</li> </ul>	<ul style="list-style-type: none"> <li>● Turn on the jets fully.</li> <li>● Turn counter-clockwise to take off the jets fitting and clean the jets chamber if blocked.</li> <li>● Turn on the air valve switch.</li> <li>● Divert the water diverter to the seat jets wanted.</li> <li>● Check the water pump ball valves are fully opened.</li> </ul>
Uneven water flow from jets	<ul style="list-style-type: none"> <li>● Suctions or filter are blocked.</li> </ul>	<ul style="list-style-type: none"> <li>● Clean the suction or filter.</li> </ul>