

LUMINA

Installation manual

Dimensions:

120x180 cm

150x180 cm

150x200 cm

Handedness

: Left



Leave space for better assembly

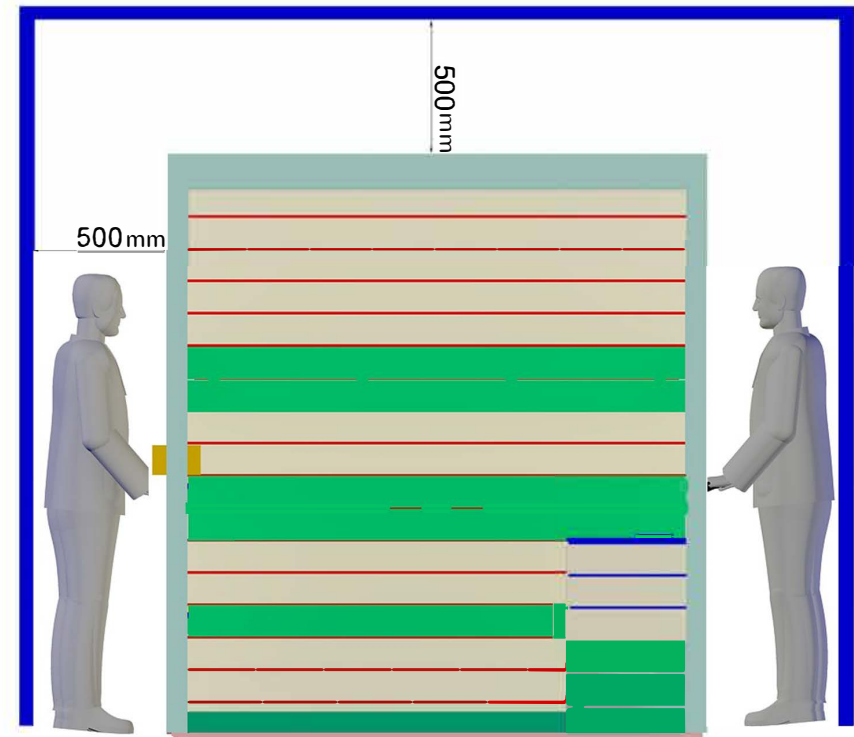
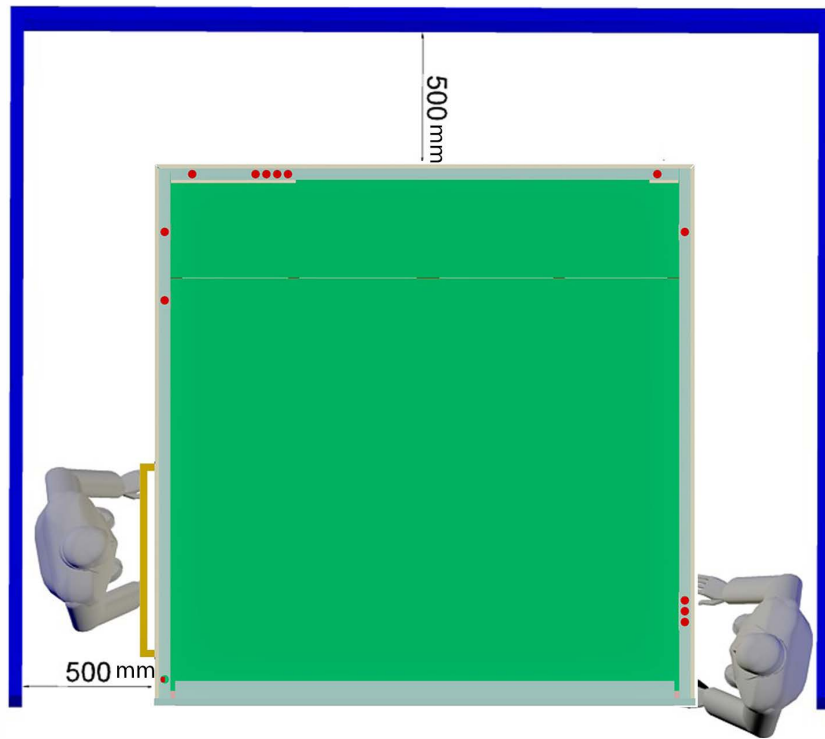

Tools

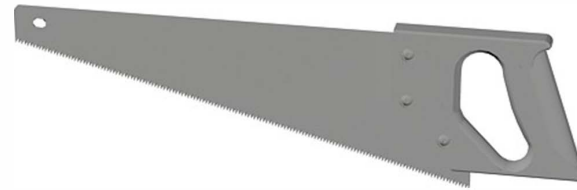
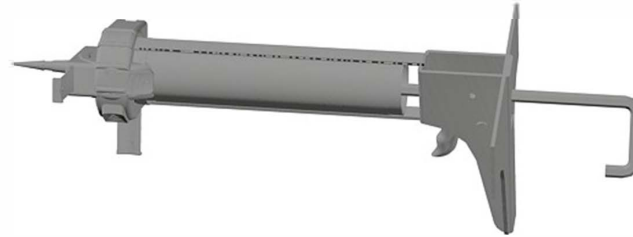

1. Base frame

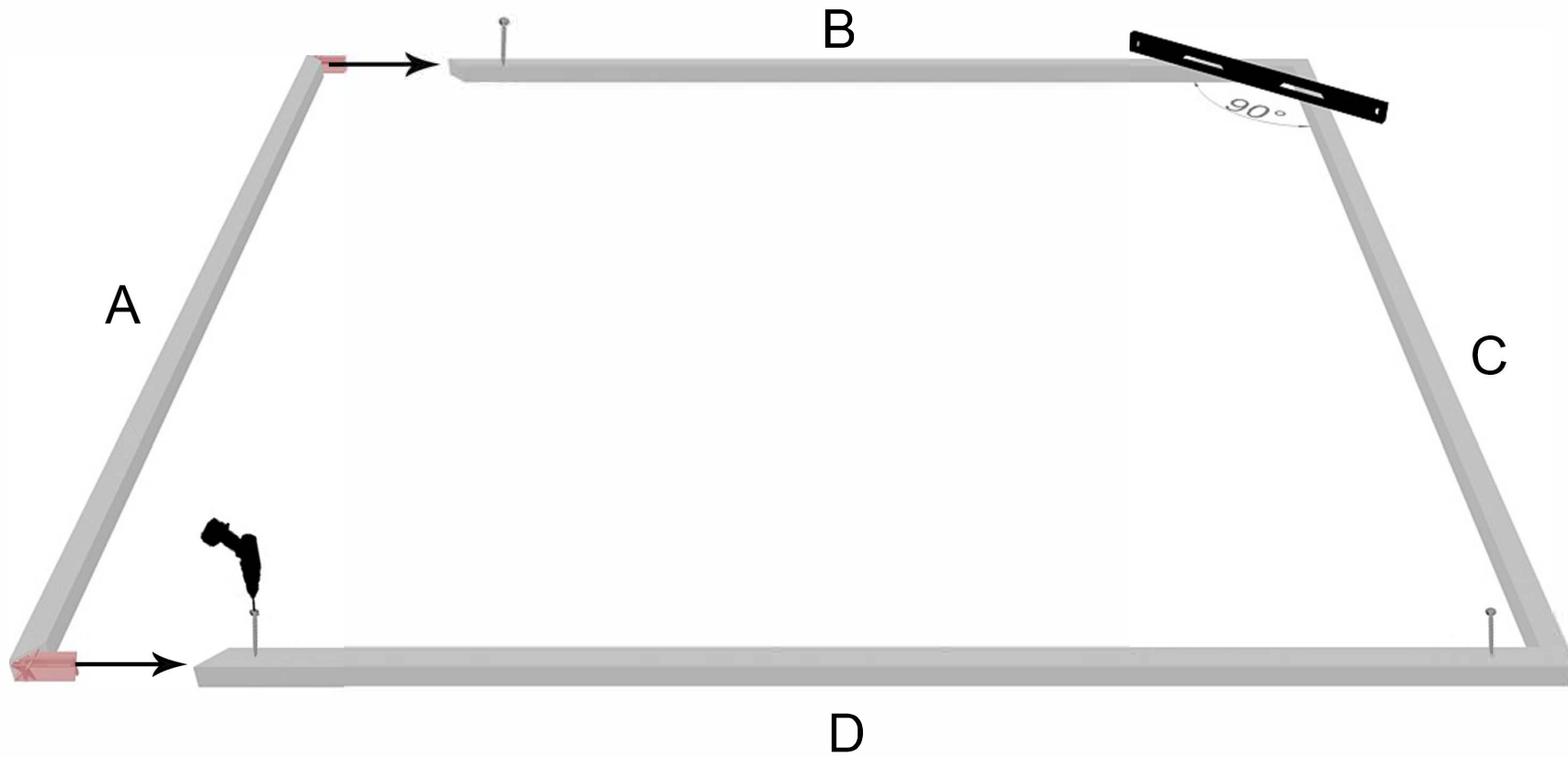

	A/C (mm)	B/D (mm)
120x180 cm	1178	1770
150x180 cm	1478	1770
150x200 cm	1478	1970

2. Walls

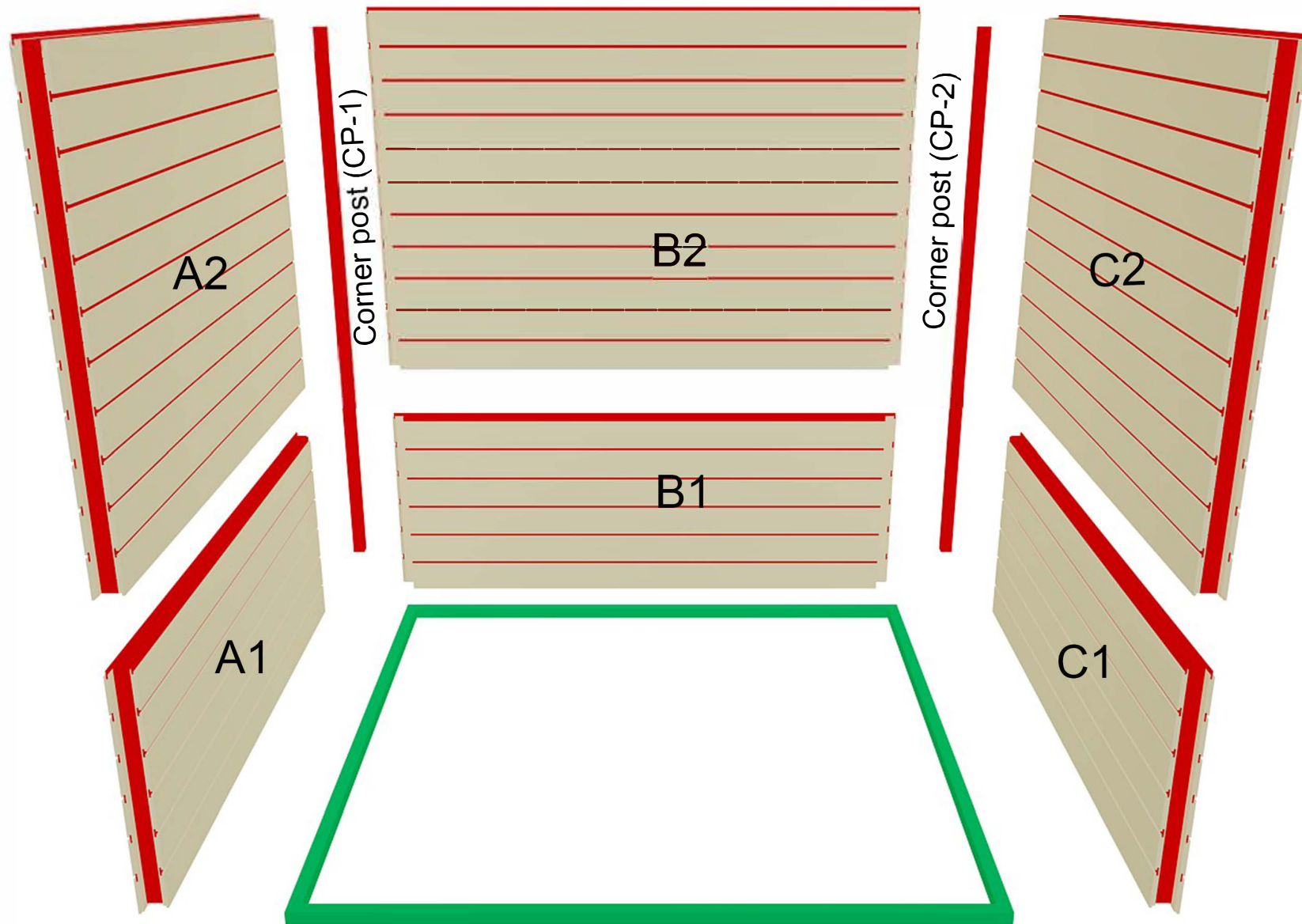

3. Multiclip closing system

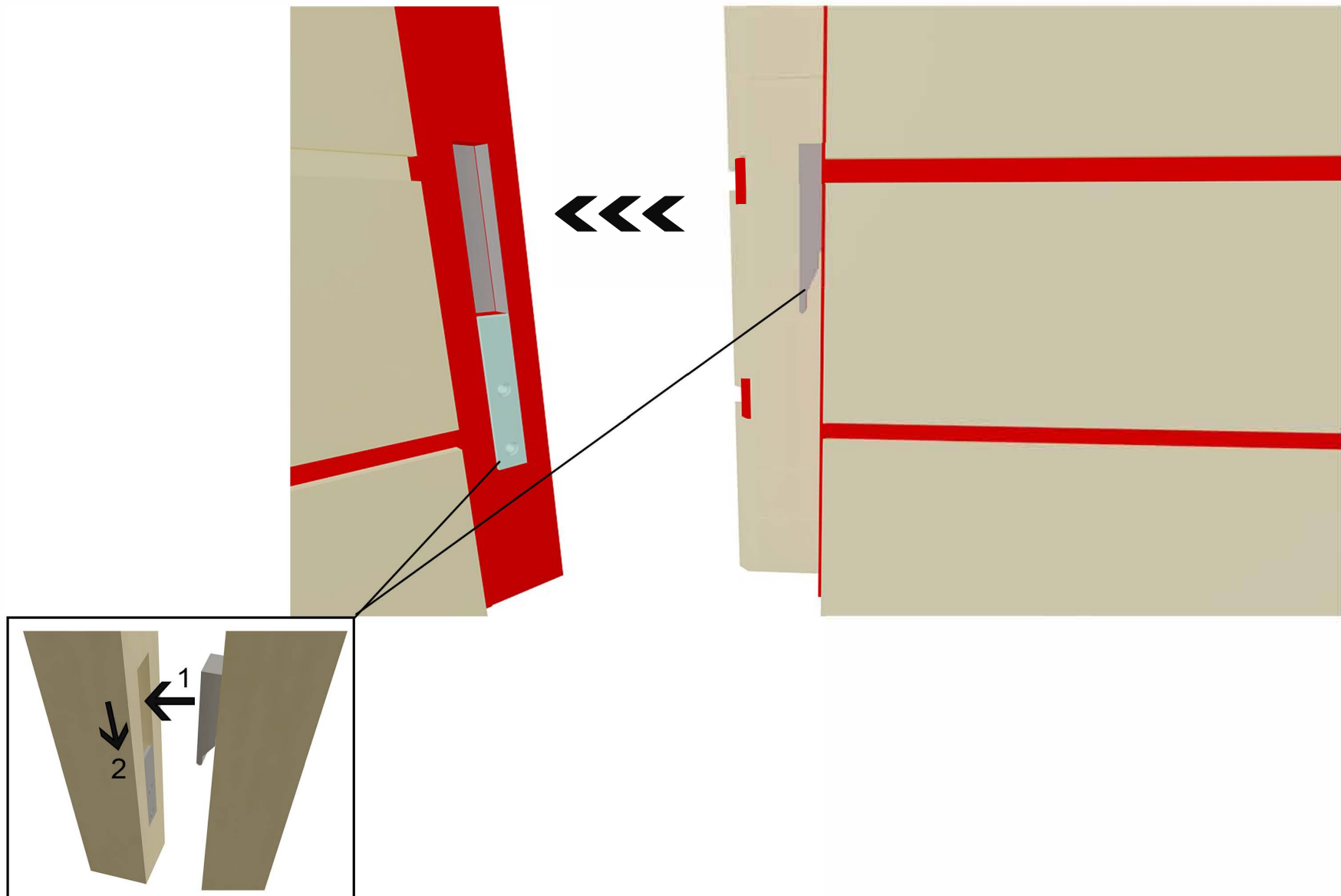

4. Fixing walls A1 & B1

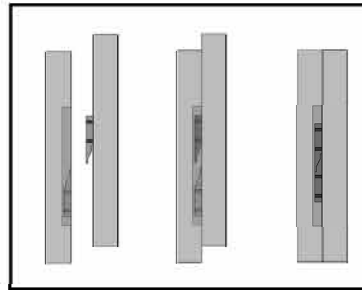
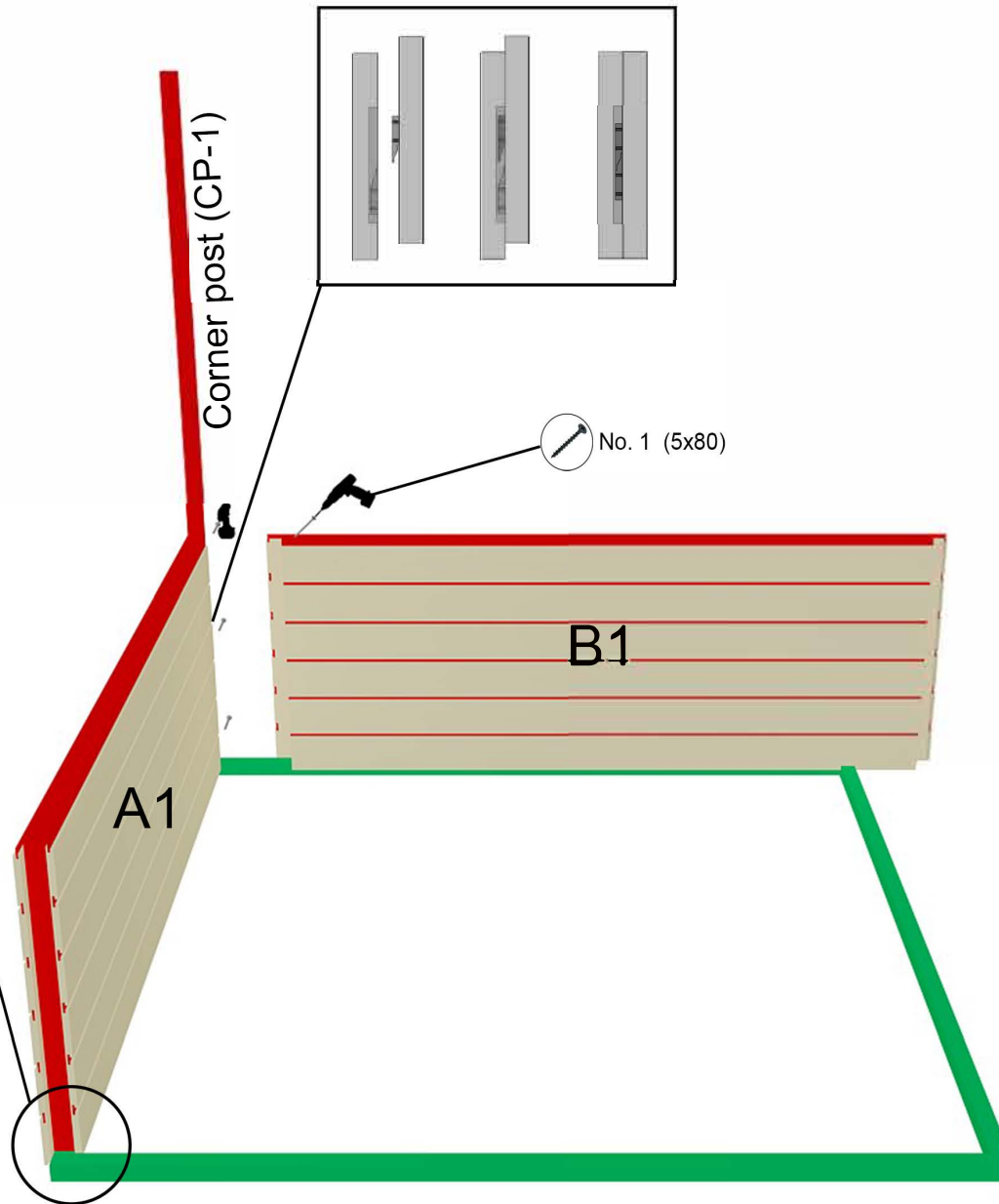
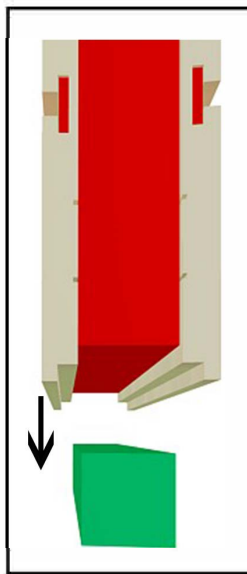
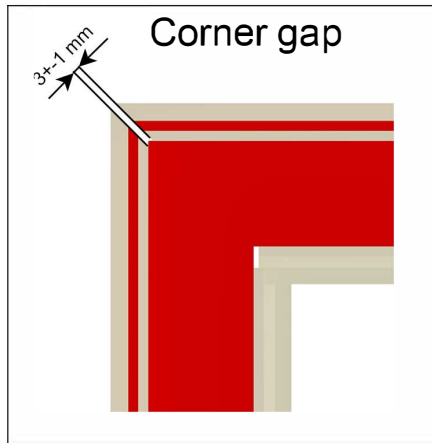

5. Fixing wall A2 & B2

No. 1 (5x80)

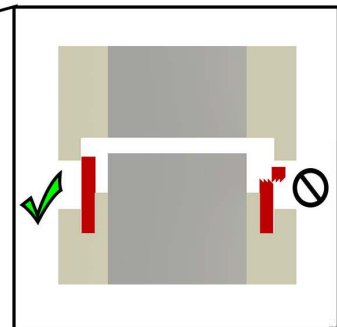
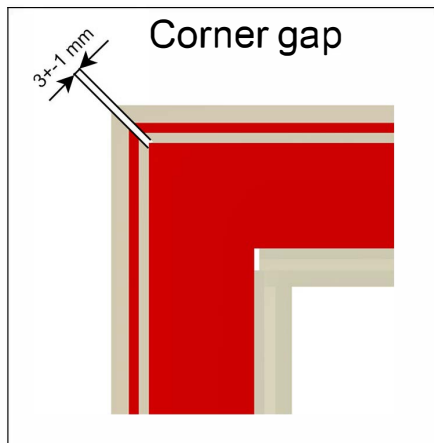
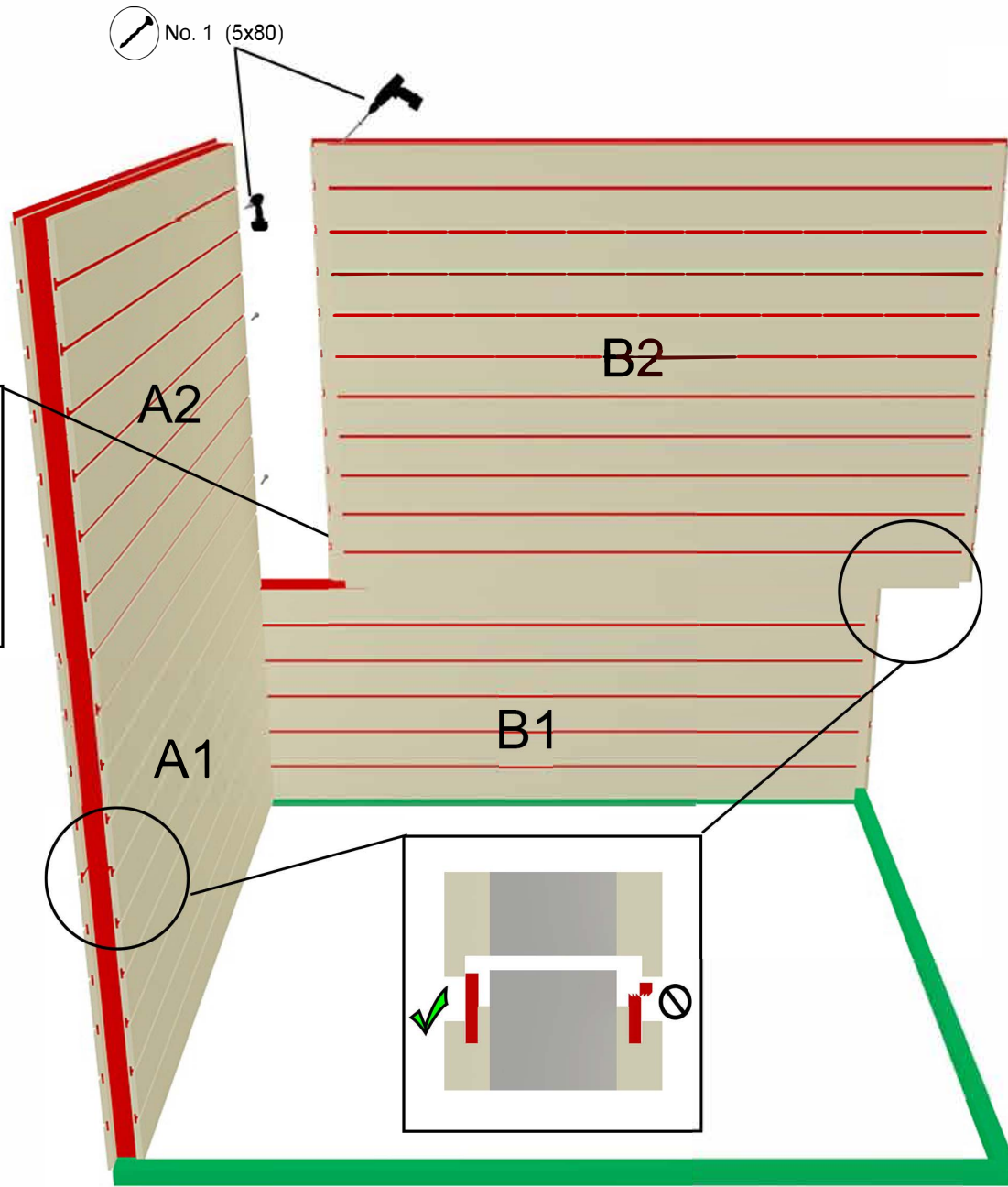
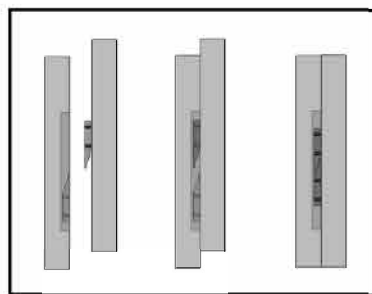

6. Fixing corner post

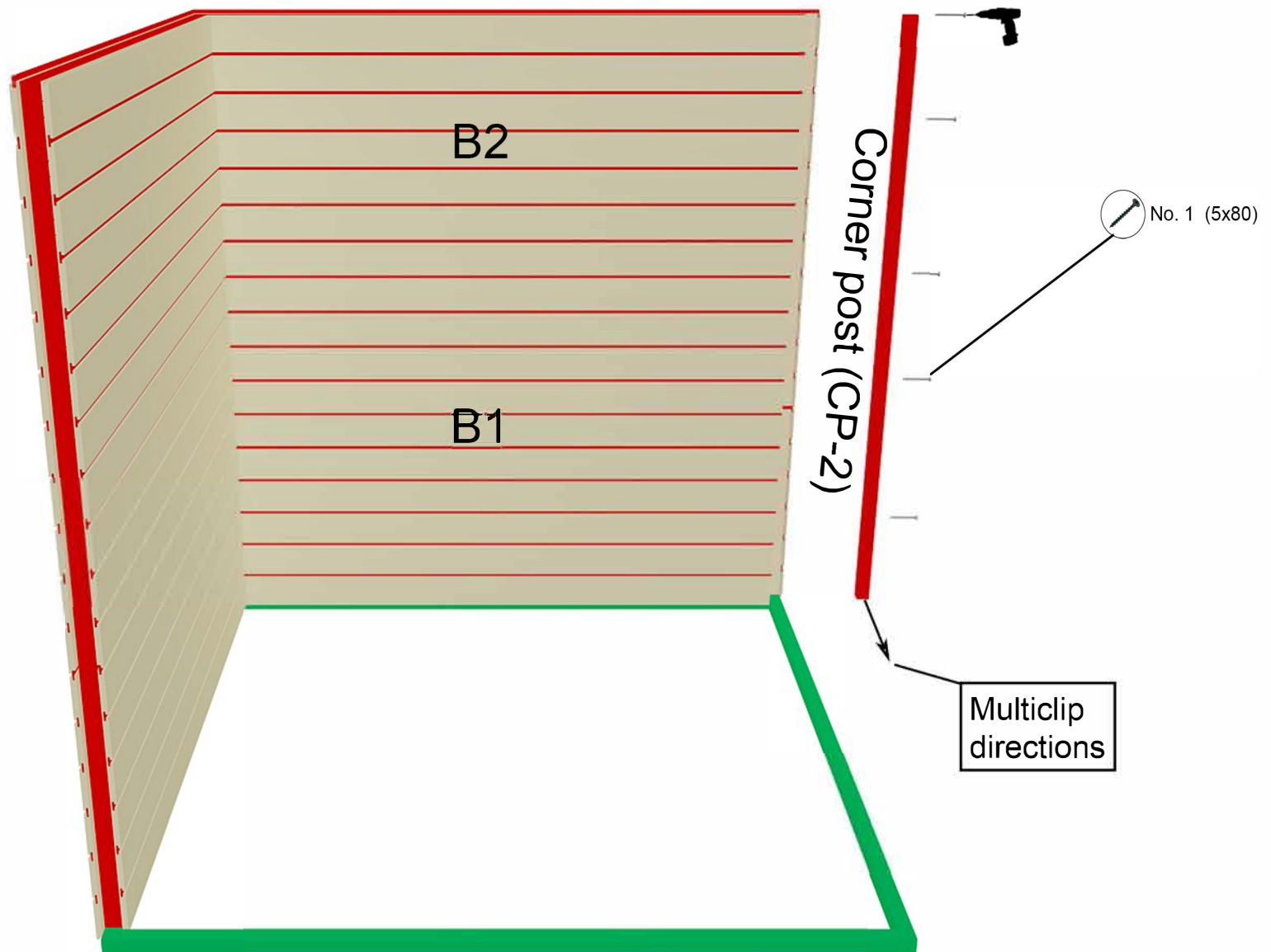

7. Fixing walls C1&C2

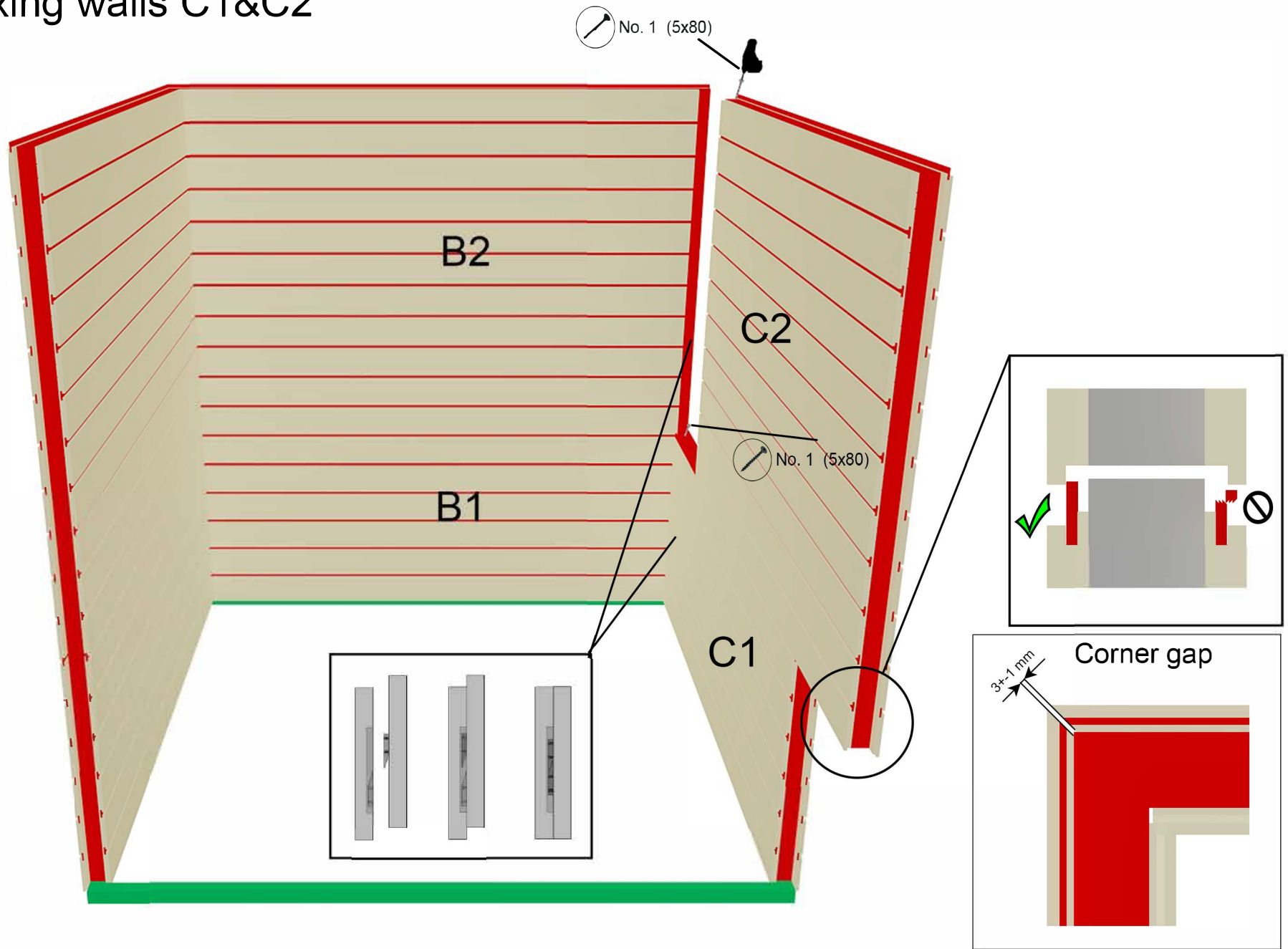

8. Fixing ceilings

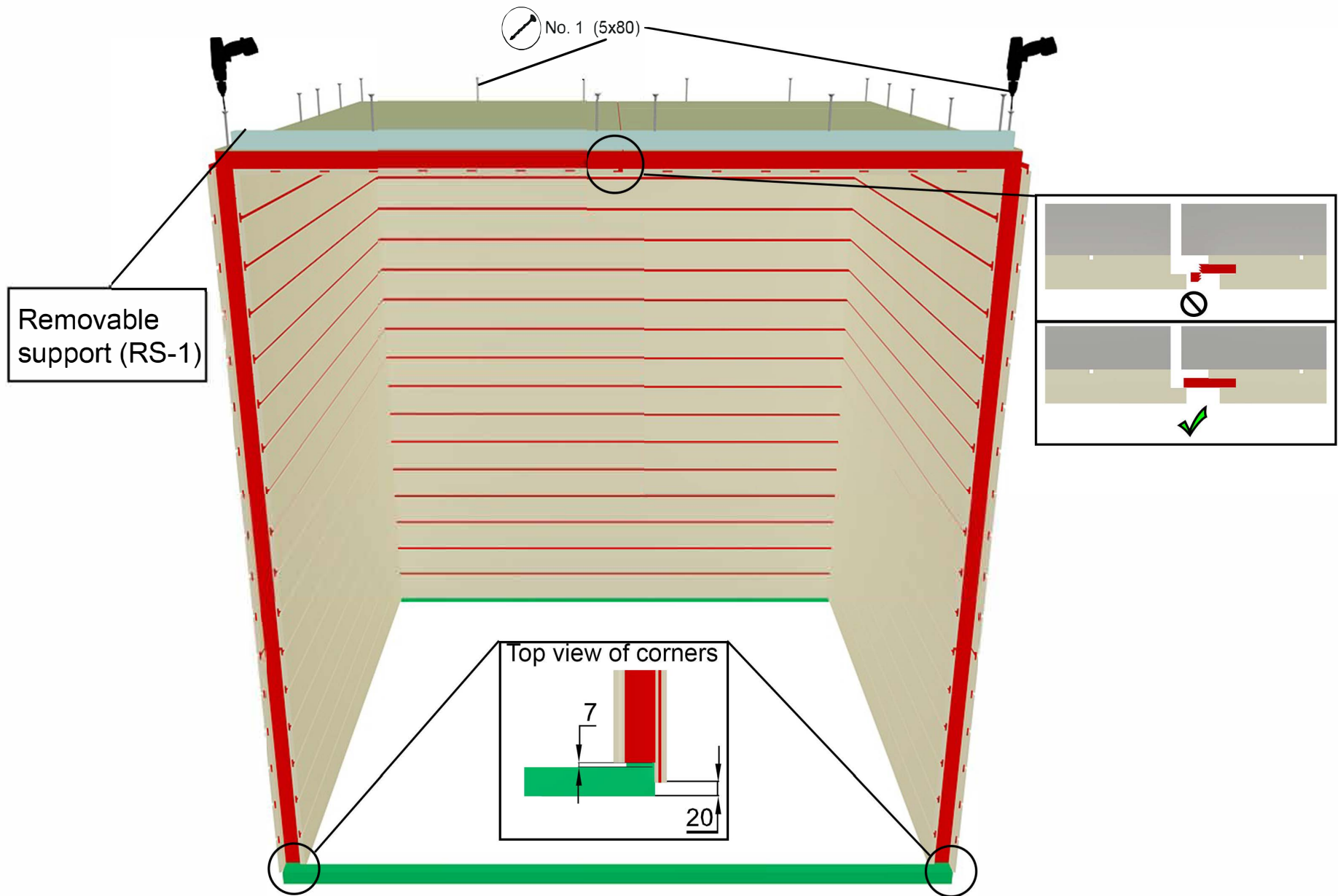

9. Wiring inside walls

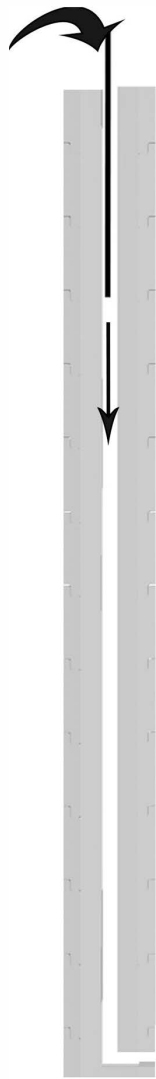

1. Push down wires from precut holes on ceiling

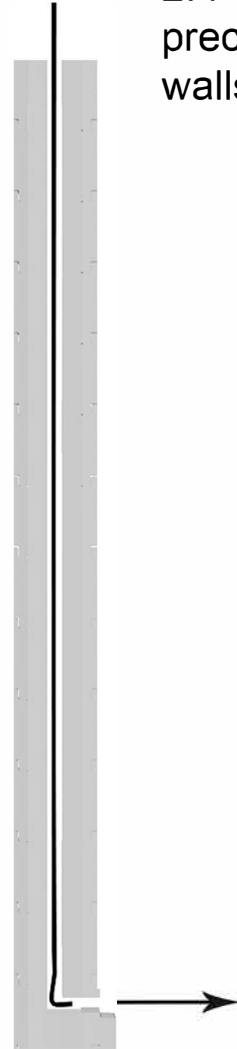

2. Pull out wires from precut holes in the walls

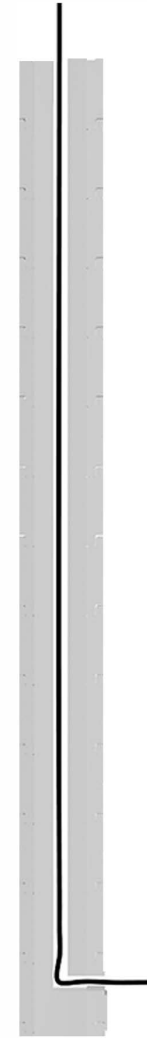

3. Connect wires

10. Interior

120x180 cm

150x180 cm

150x200 cm

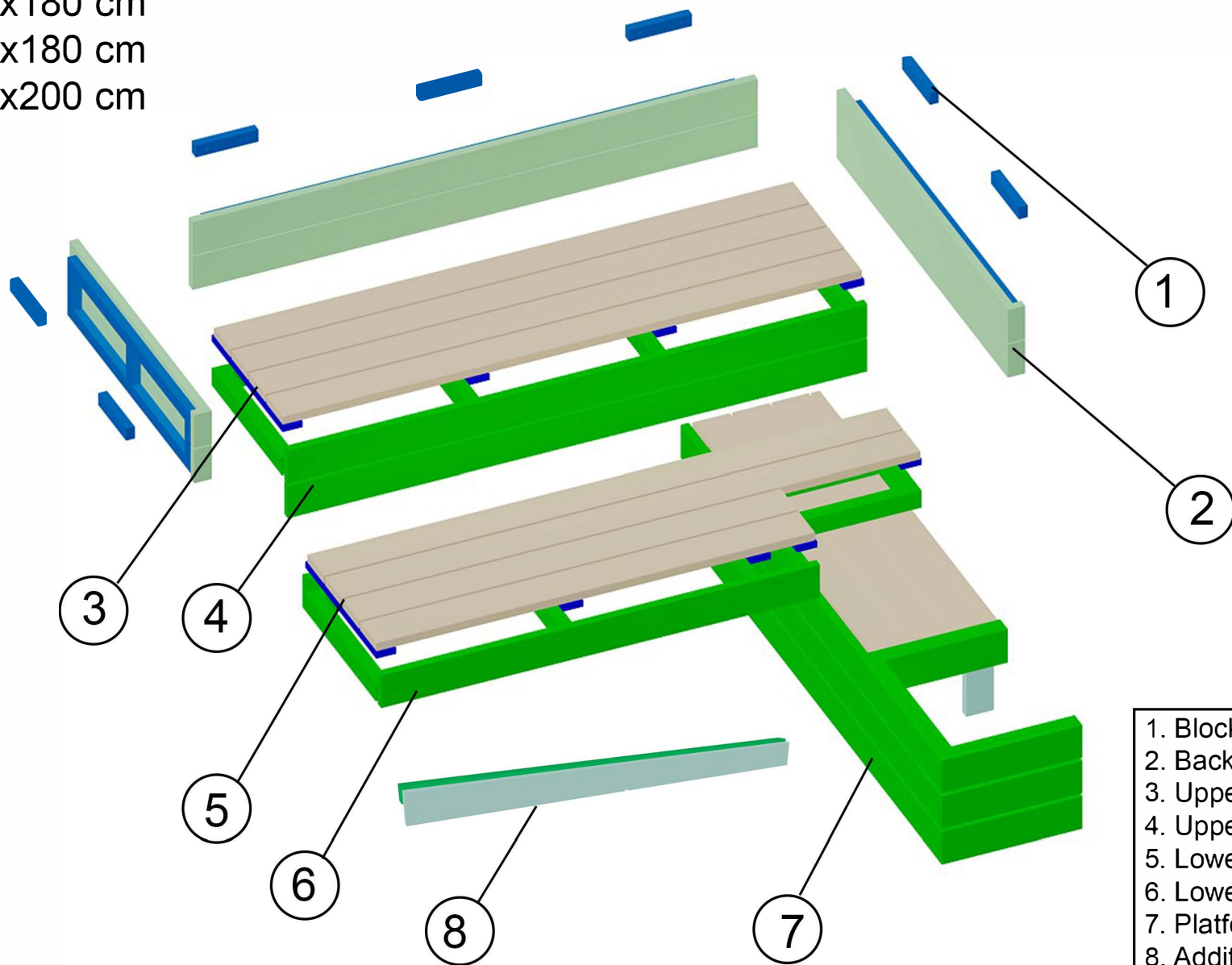

1. Block for fixing backrests
2. Backrests
3. Upper bench grid
4. Upper bench frame
5. Lower bench grid
6. Lower bench frame
7. Platform
8. Additional support for model 120x180 cm

10.1 Assembly of platform

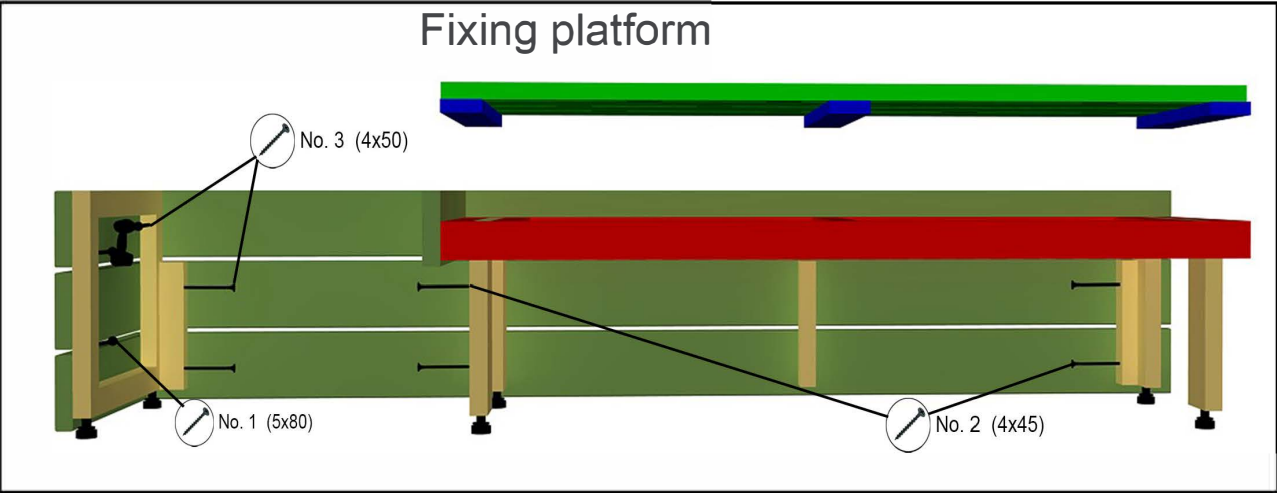
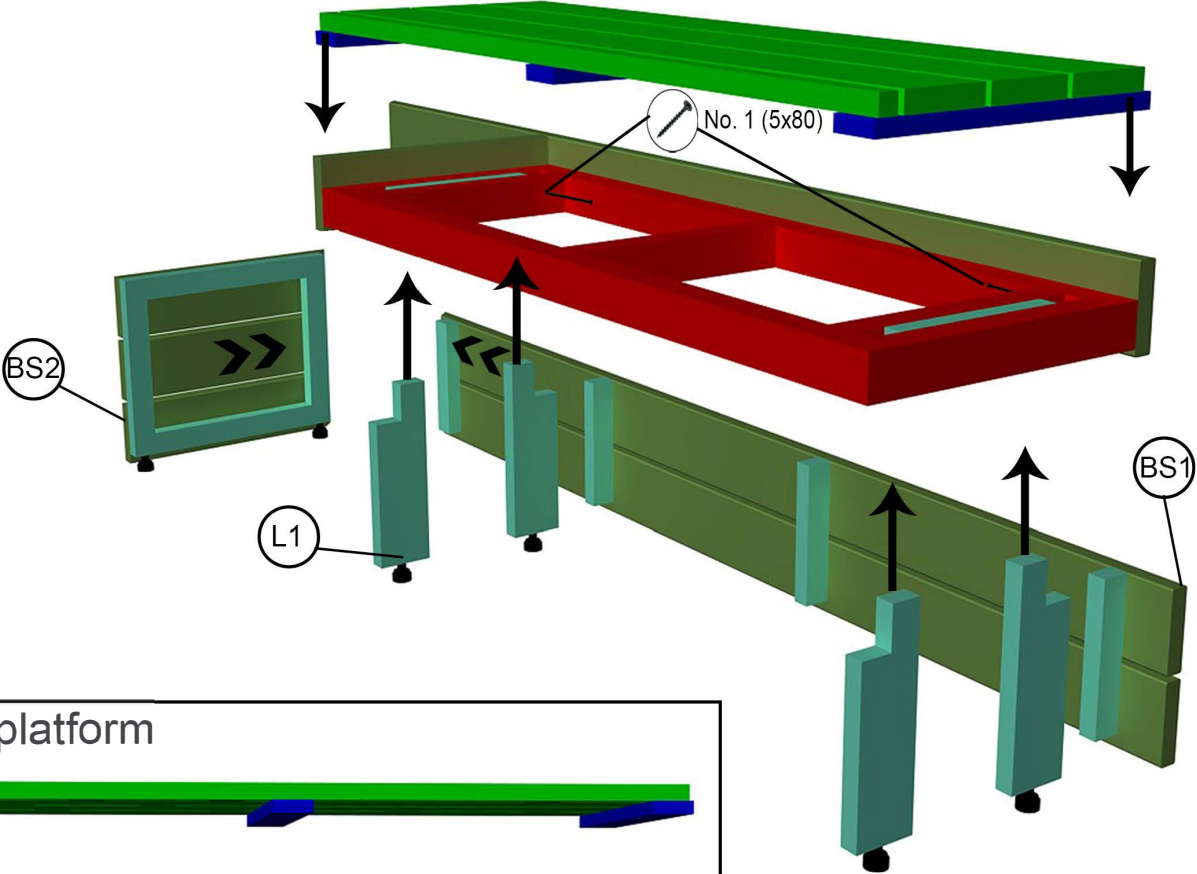

10.2 Upper bench frame & blocks for backrest

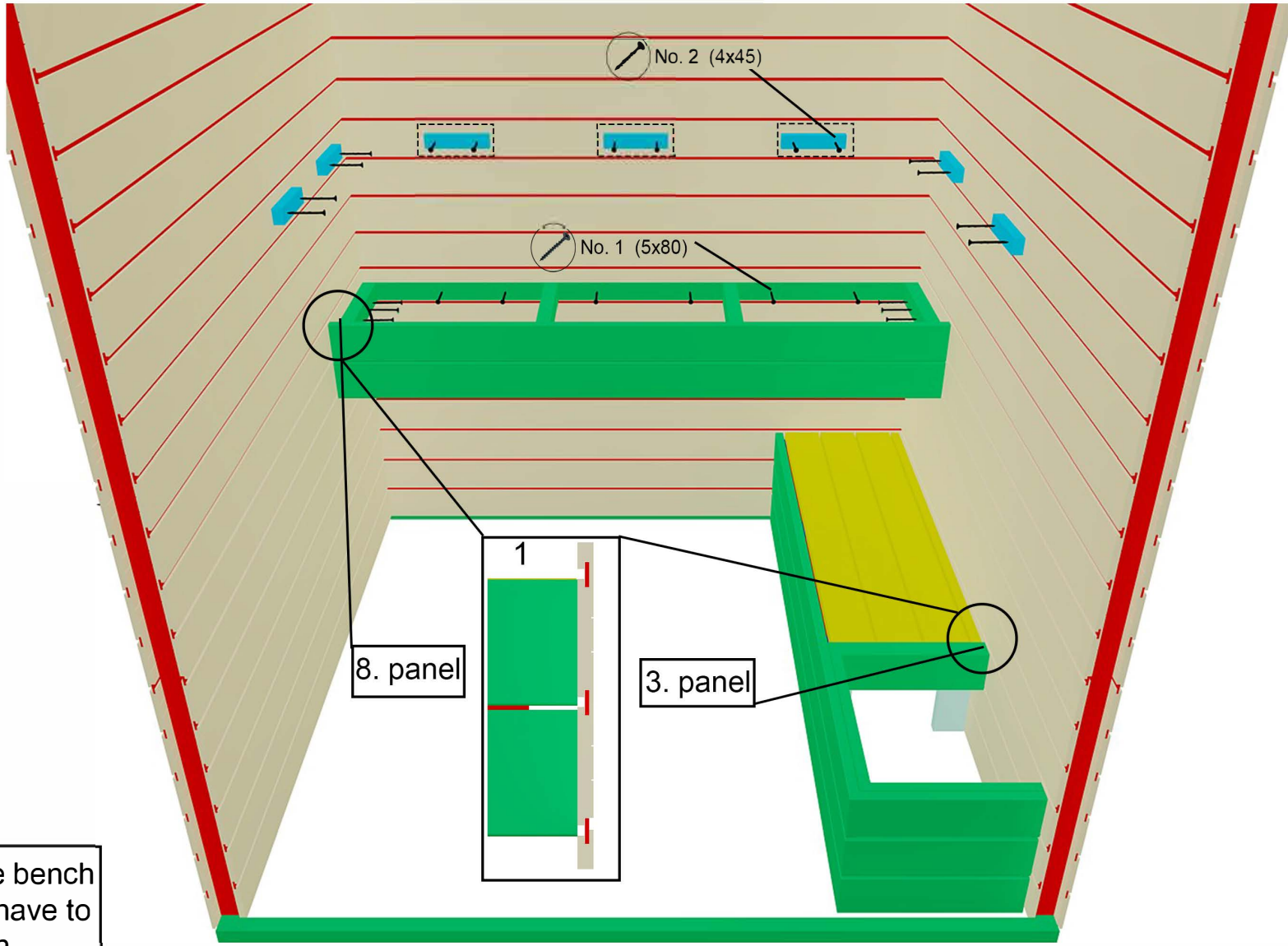

1. Frontside of the bench frame & platform have to be same level with paneling as shown

10.3 Cariitti optic fibre for upper bench (Optional)

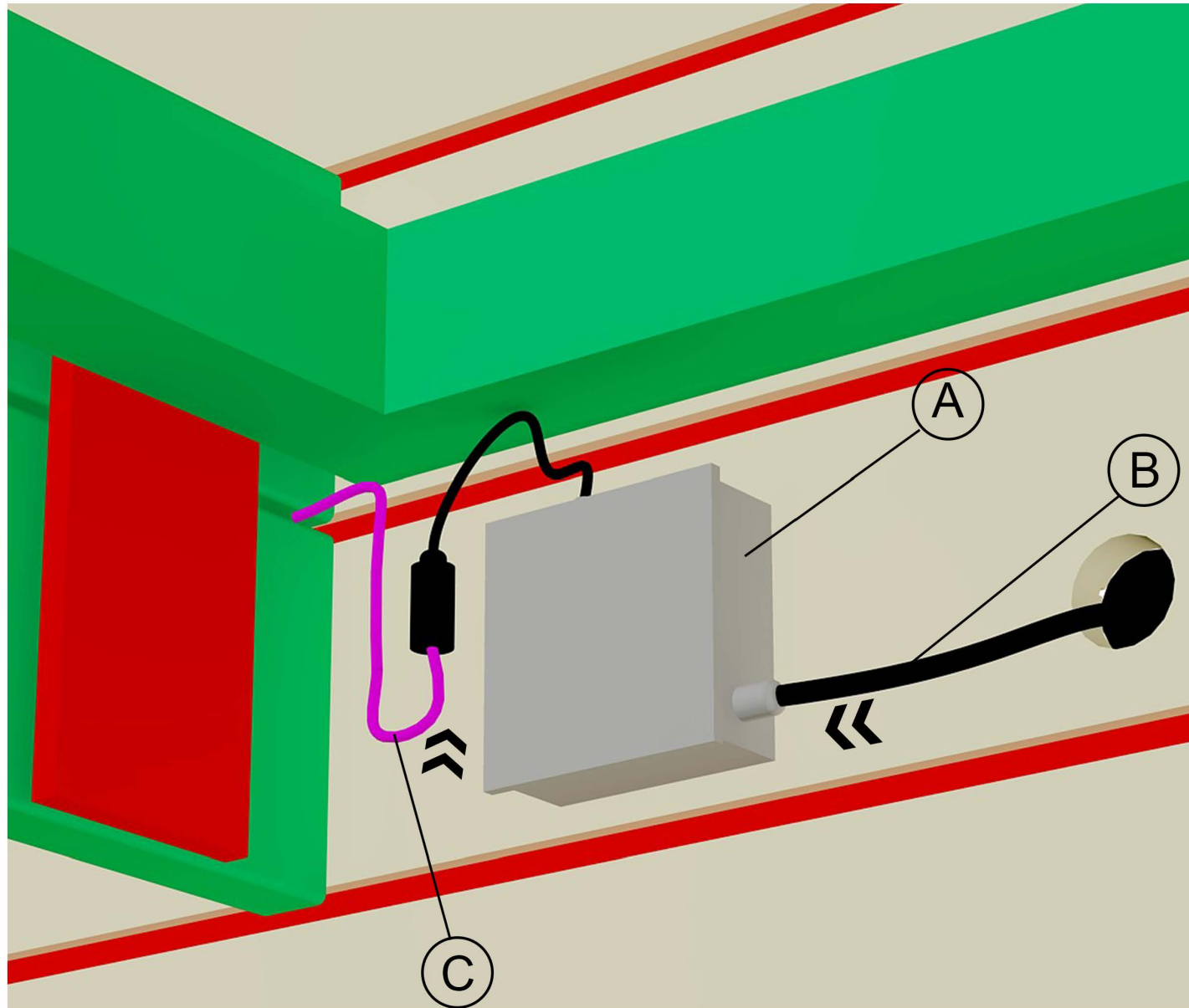

A. Projector
B. Power cable
C. Fibre

1. Push down power cable from the ceiling
2. Connect power cable with projector
3. Push fiber in gap between upper bench frontboards
4. Connect fibre with projector

10.4 Lower bench frame fixing

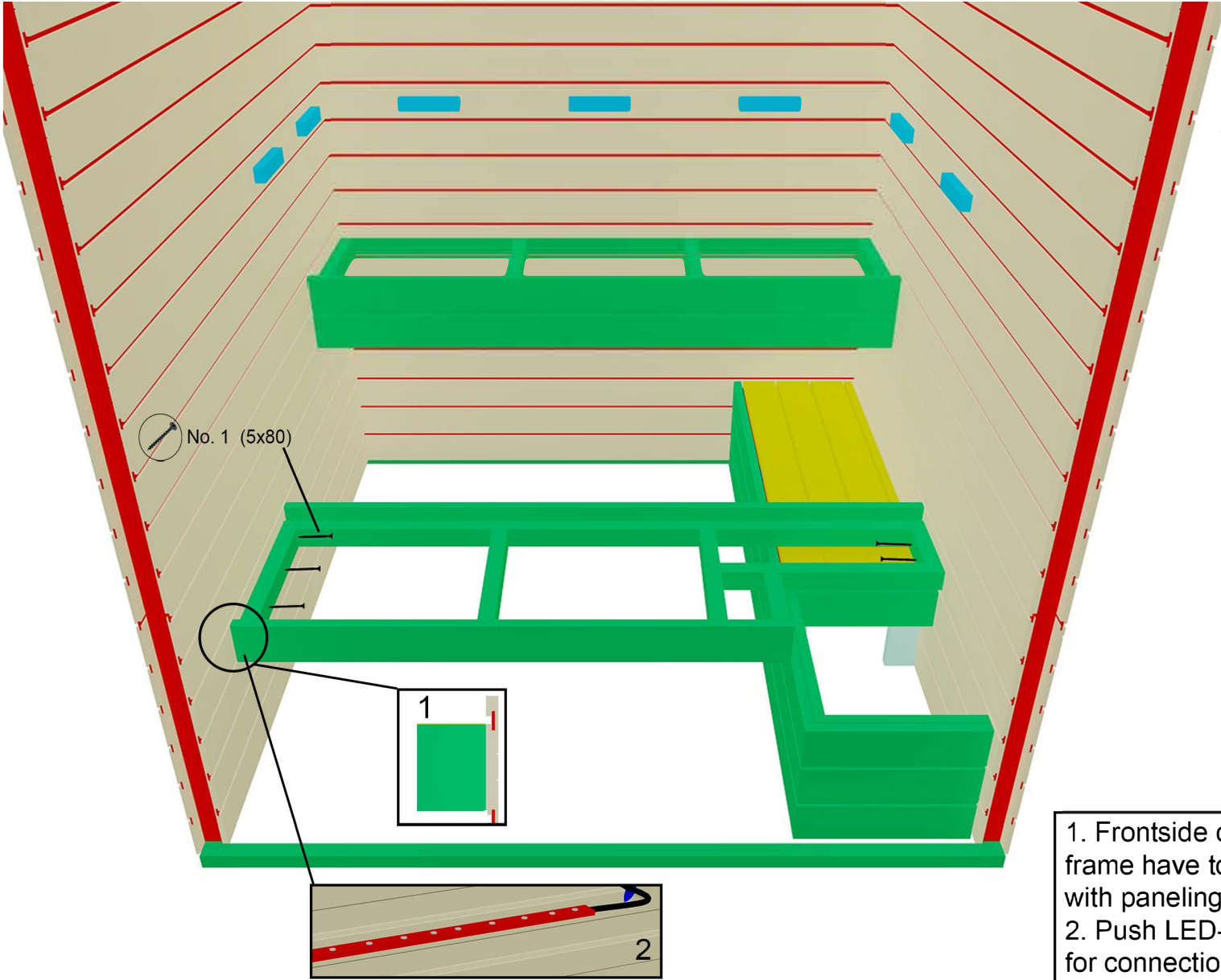

- 1. Frontside of the bench frame have to be same level with paneling as shown
- 2. Push LED-strip to ceiling for connection

10.5 Additional support fixing 120x180 cm

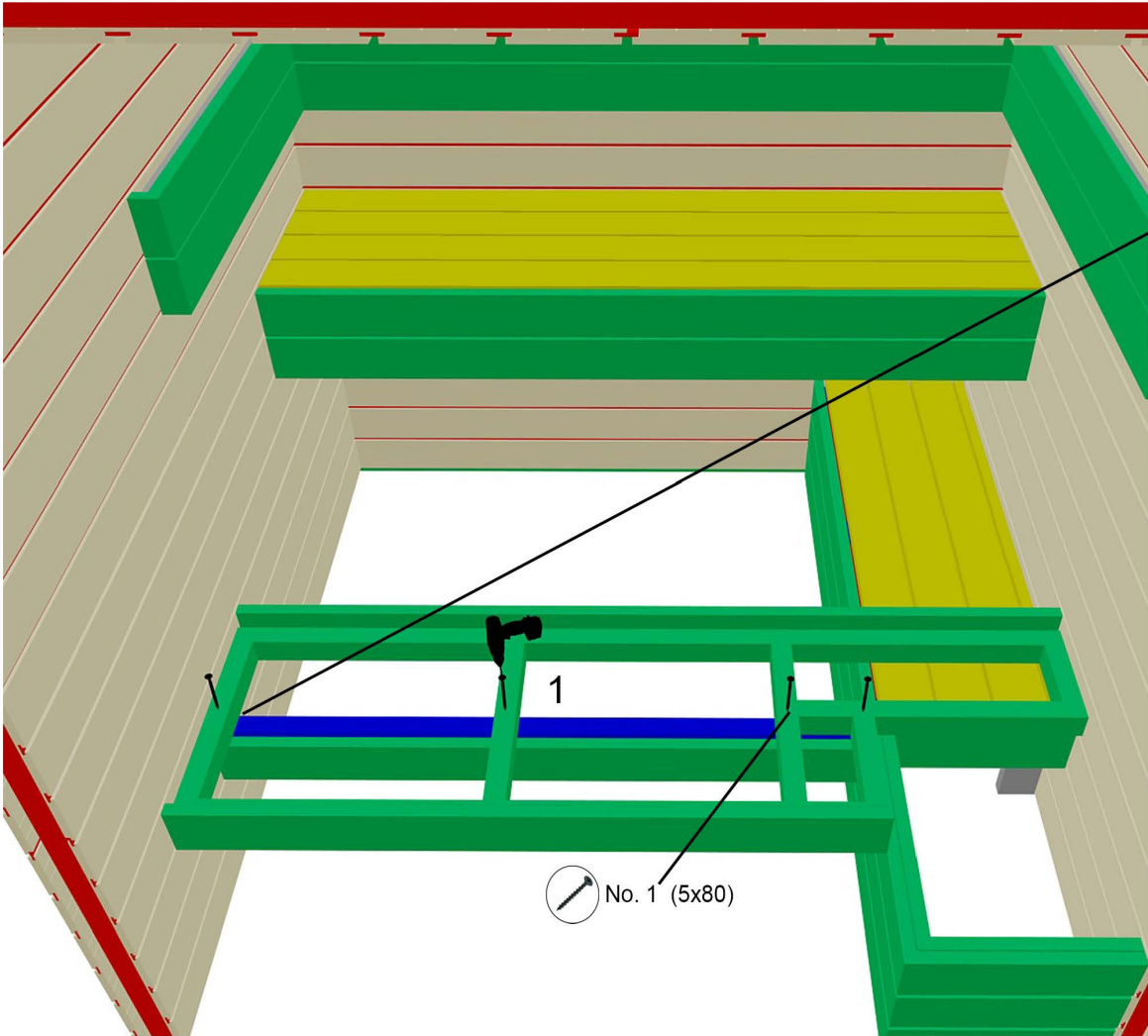

No. 1 (5x80)

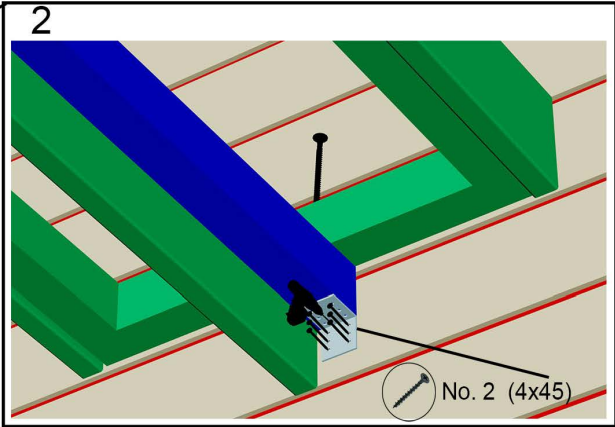

No. 2 (4x45)

11. Backrest LED-strips

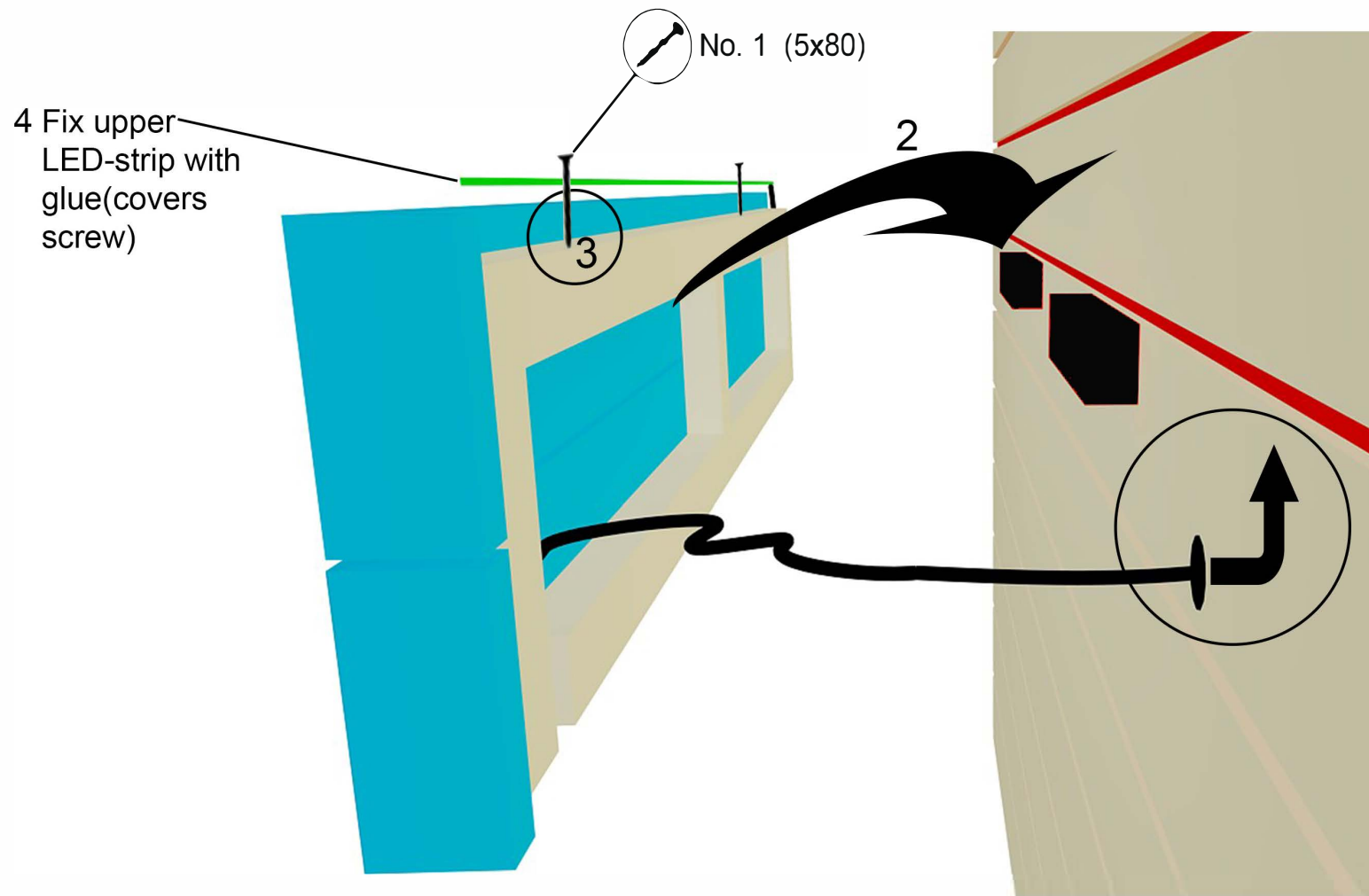

11.1 Fixing backrests

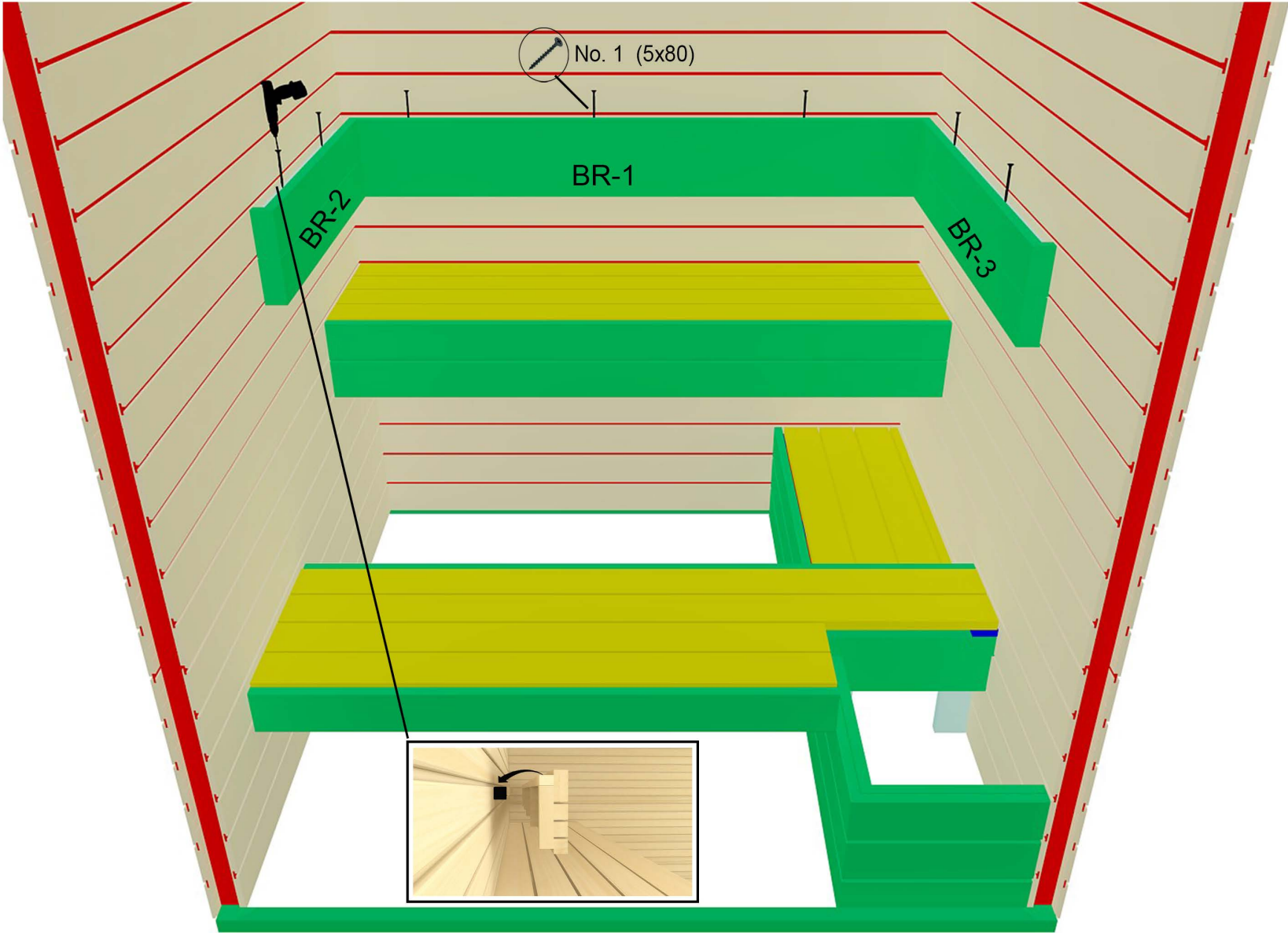

12. Interior II

120x180 cm

150x180 cm

150x200 cm

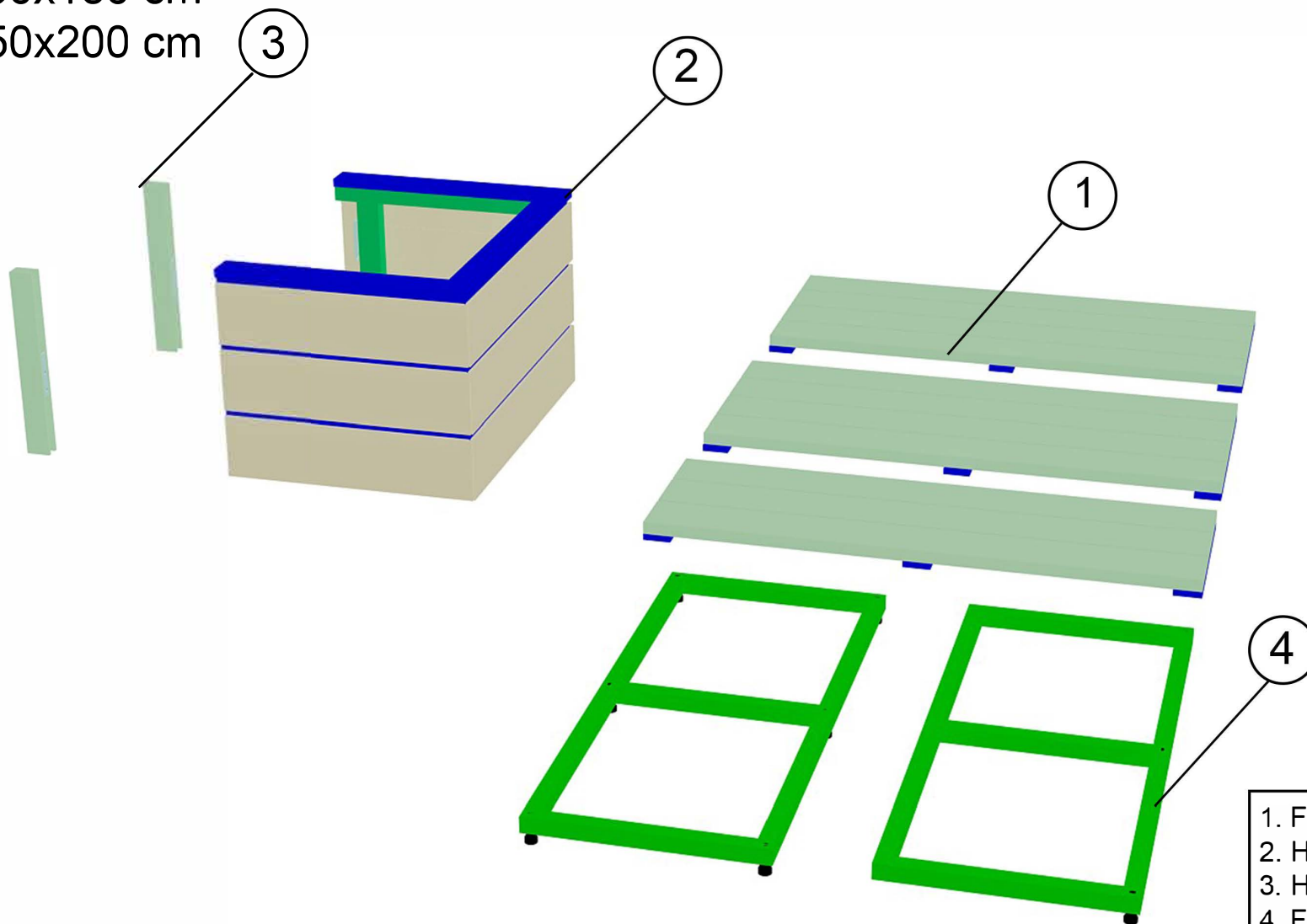

- 1. Floor grids
- 2. Heater guard
- 3. Heater guard holders
- 4. Floor grid frames with regulation feets

13. Fixing heater guard

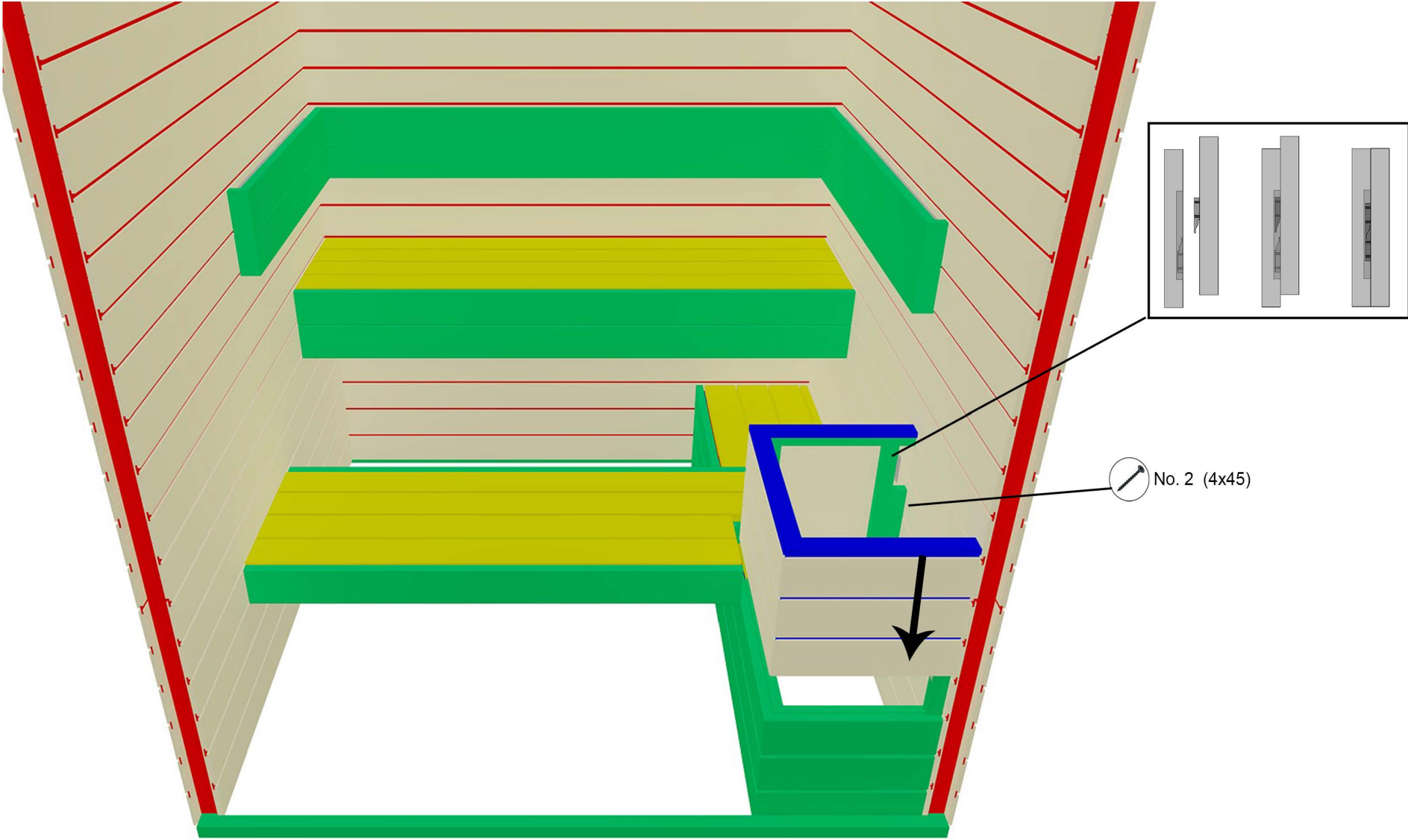

14. Glass wall & door frames

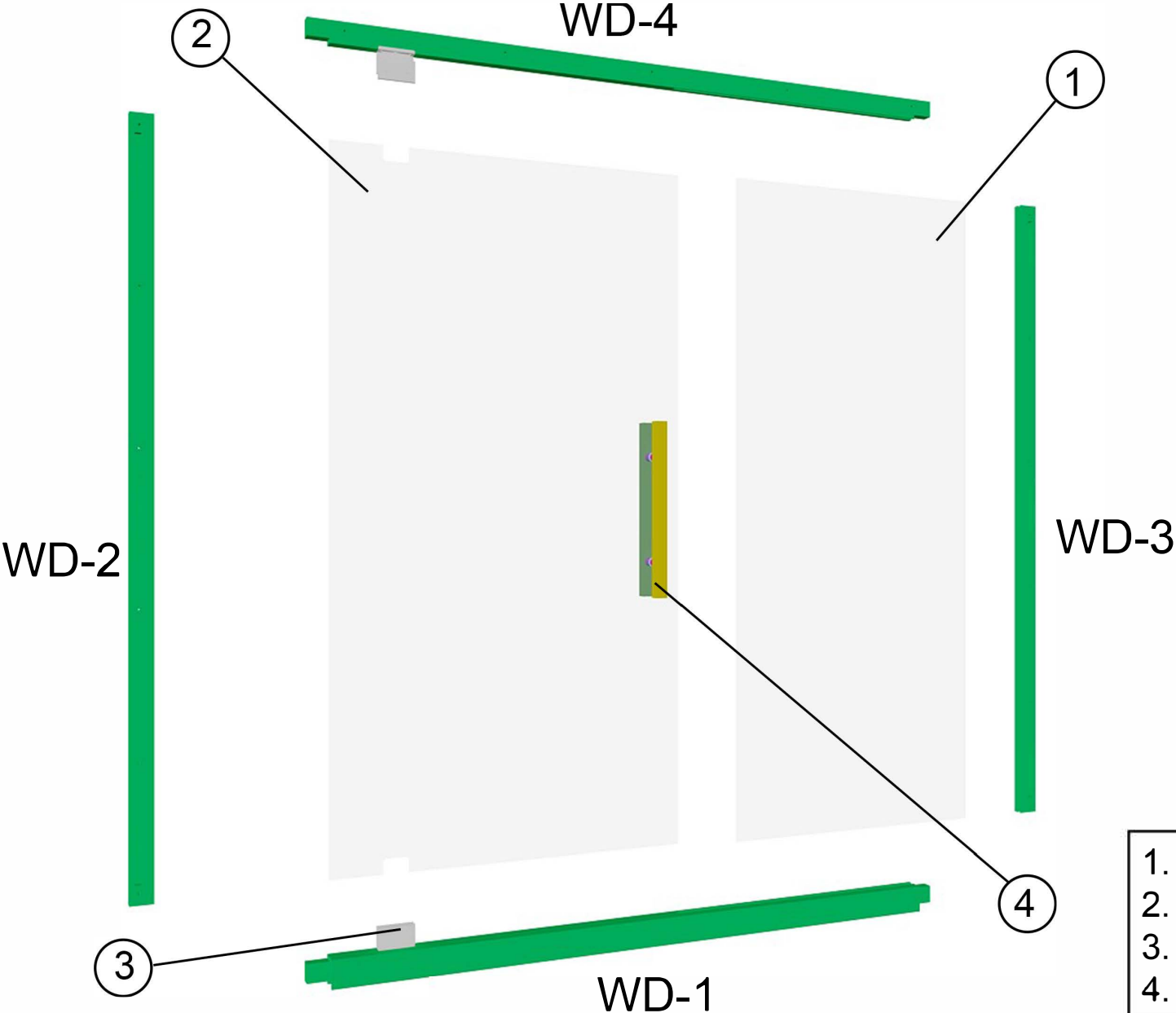

- 1. Glass wall glass
- 2. Door glass
- 3. Door hinge
- 4. Door handle

15. Fixing glass wall & door frames

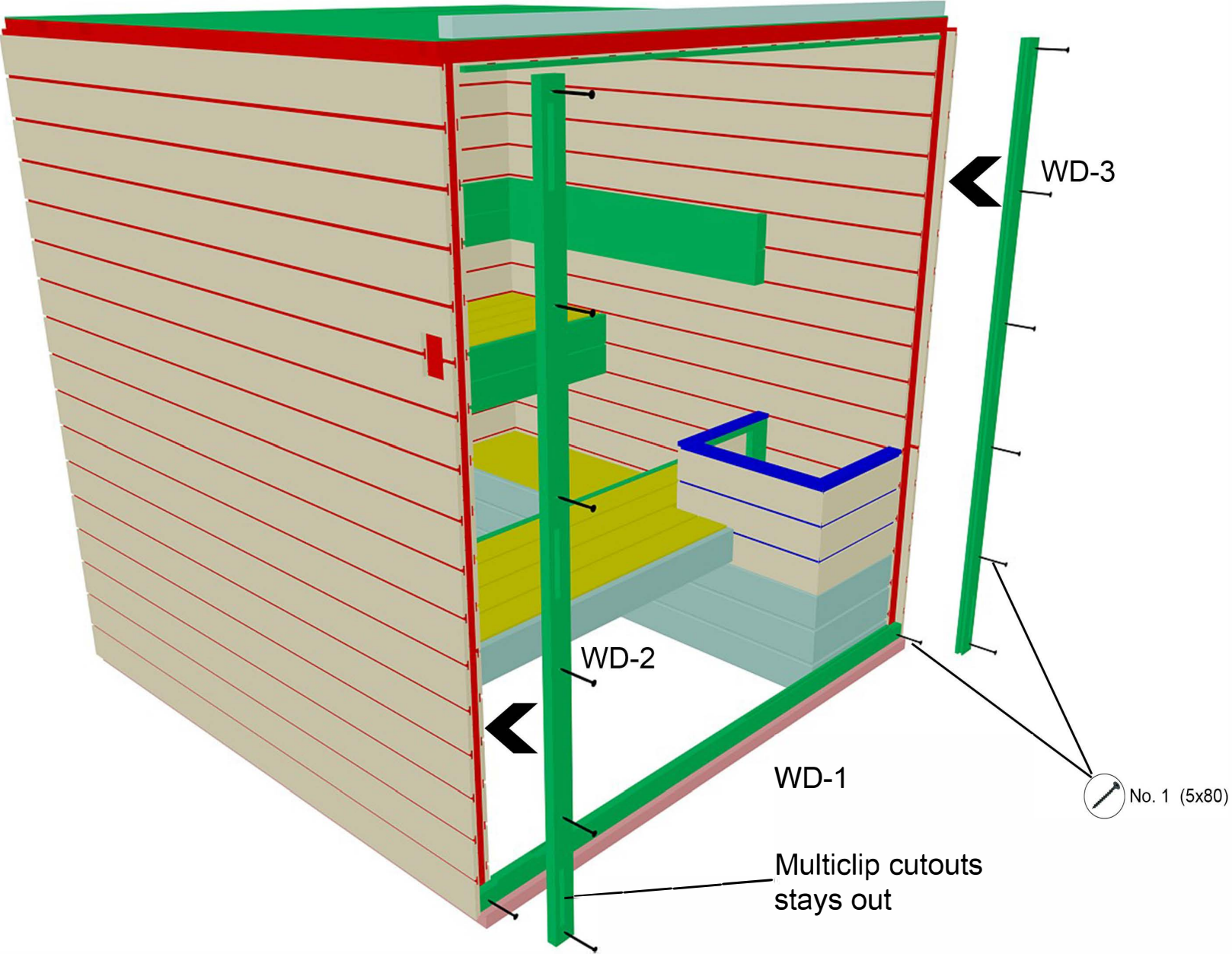

15.1 Fixing glass wall

No. 1 (5x80)

WD-4

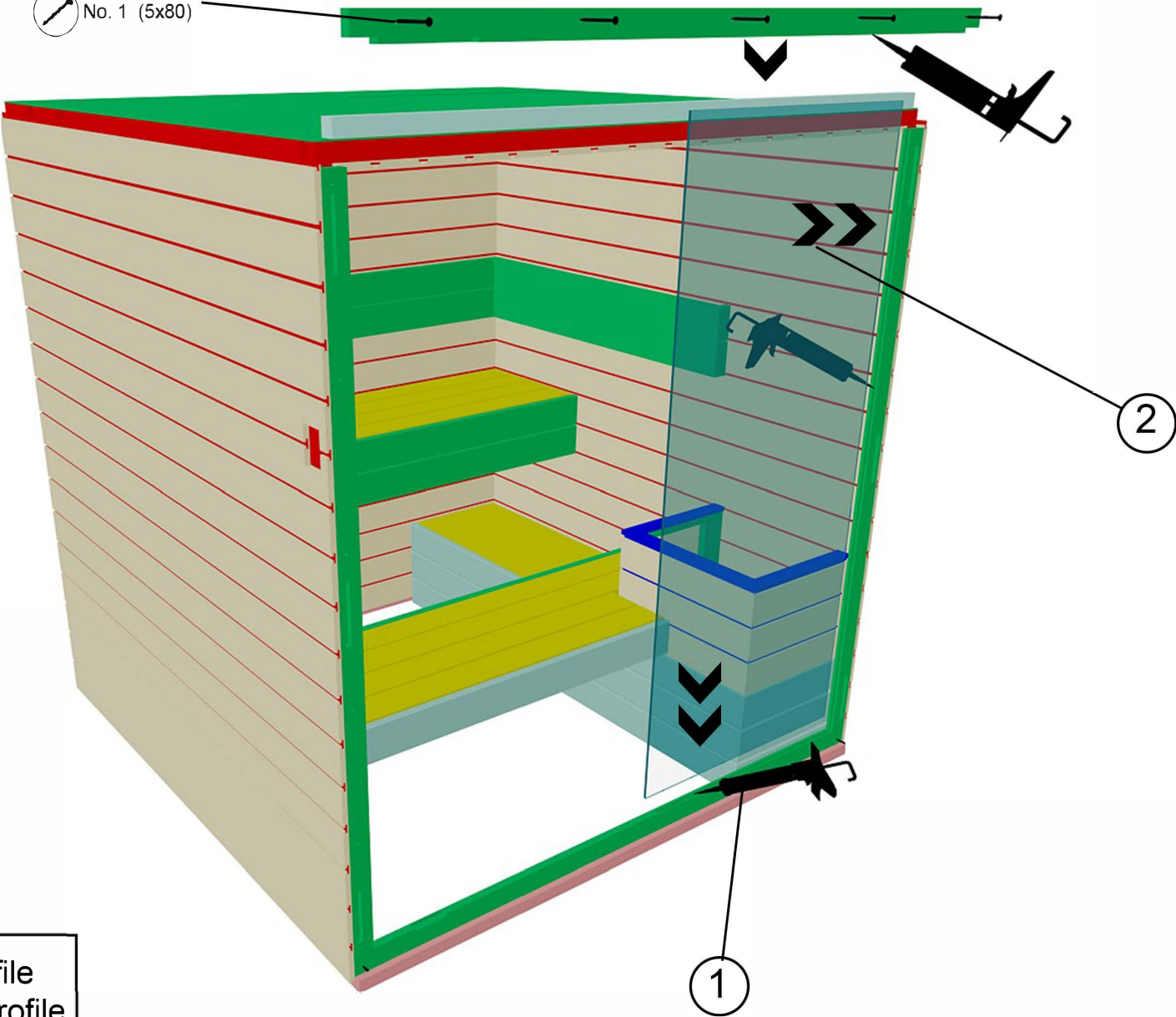

- 1. Add glue in u-profile
- 2. Push glass in u-profile

15.2 Multiclips for frames

RS-1

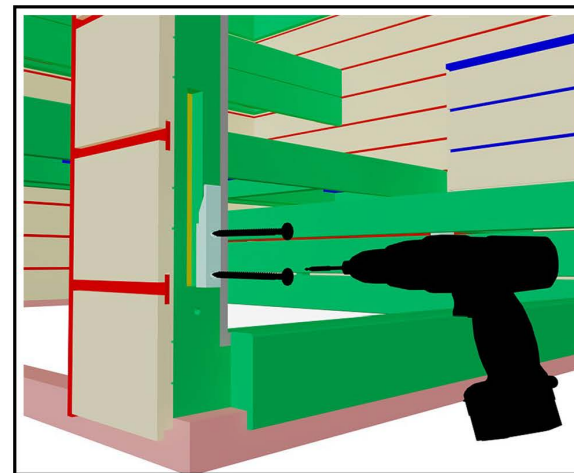
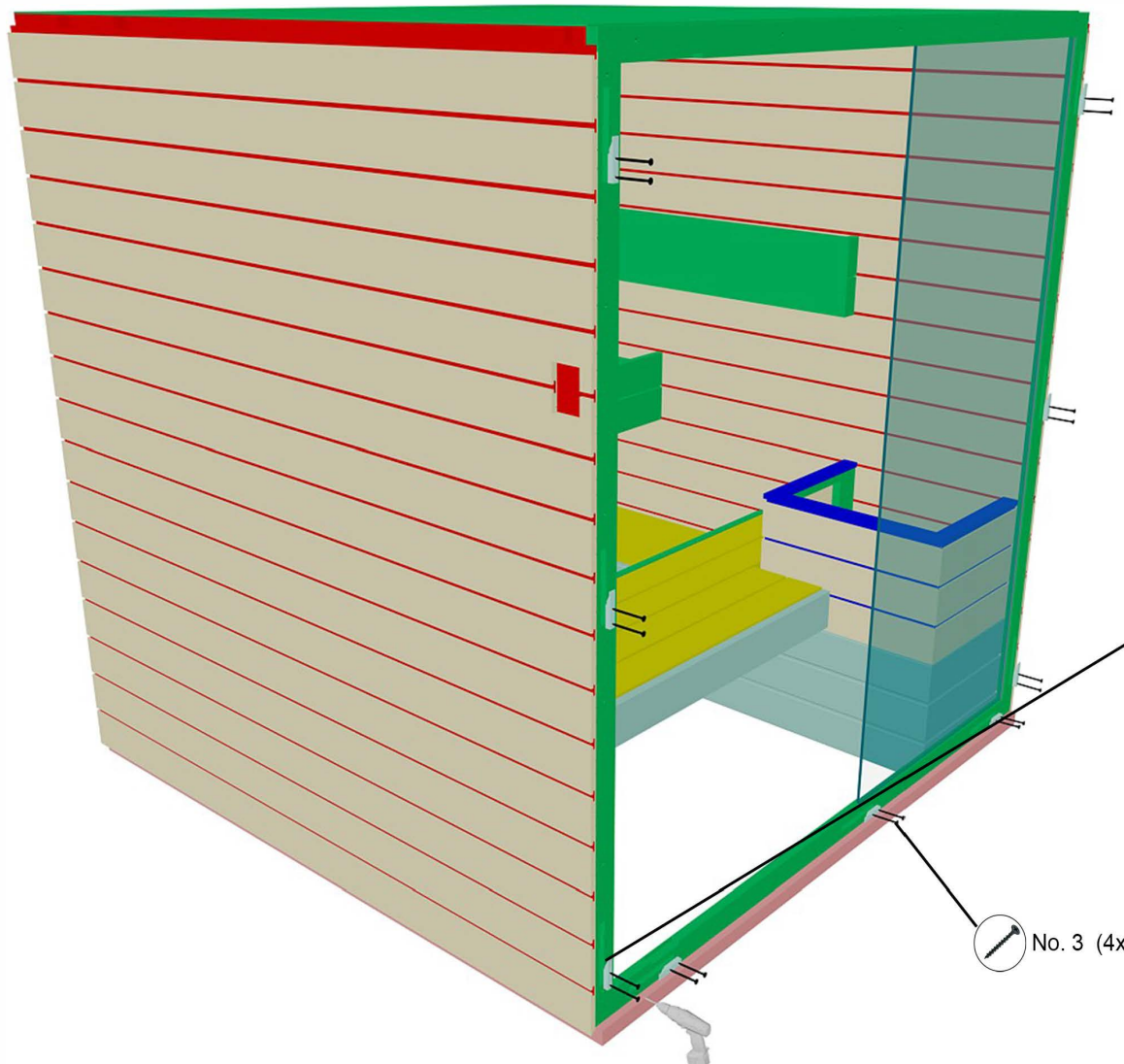

No. 3 (4x50)

15.3 Door hinges and glass

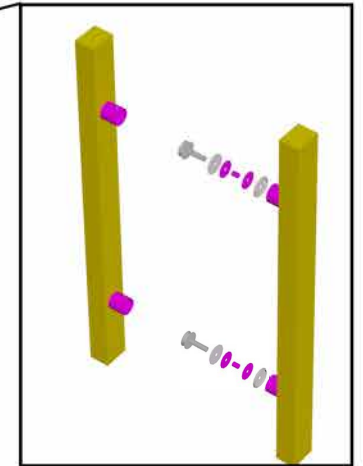
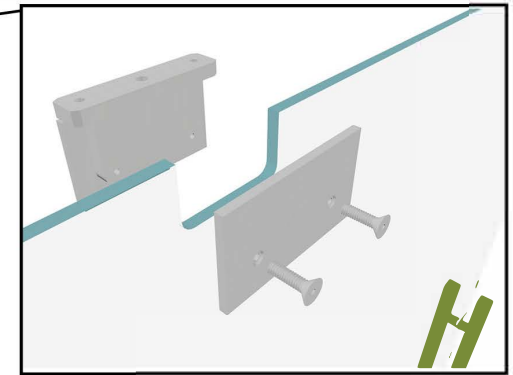
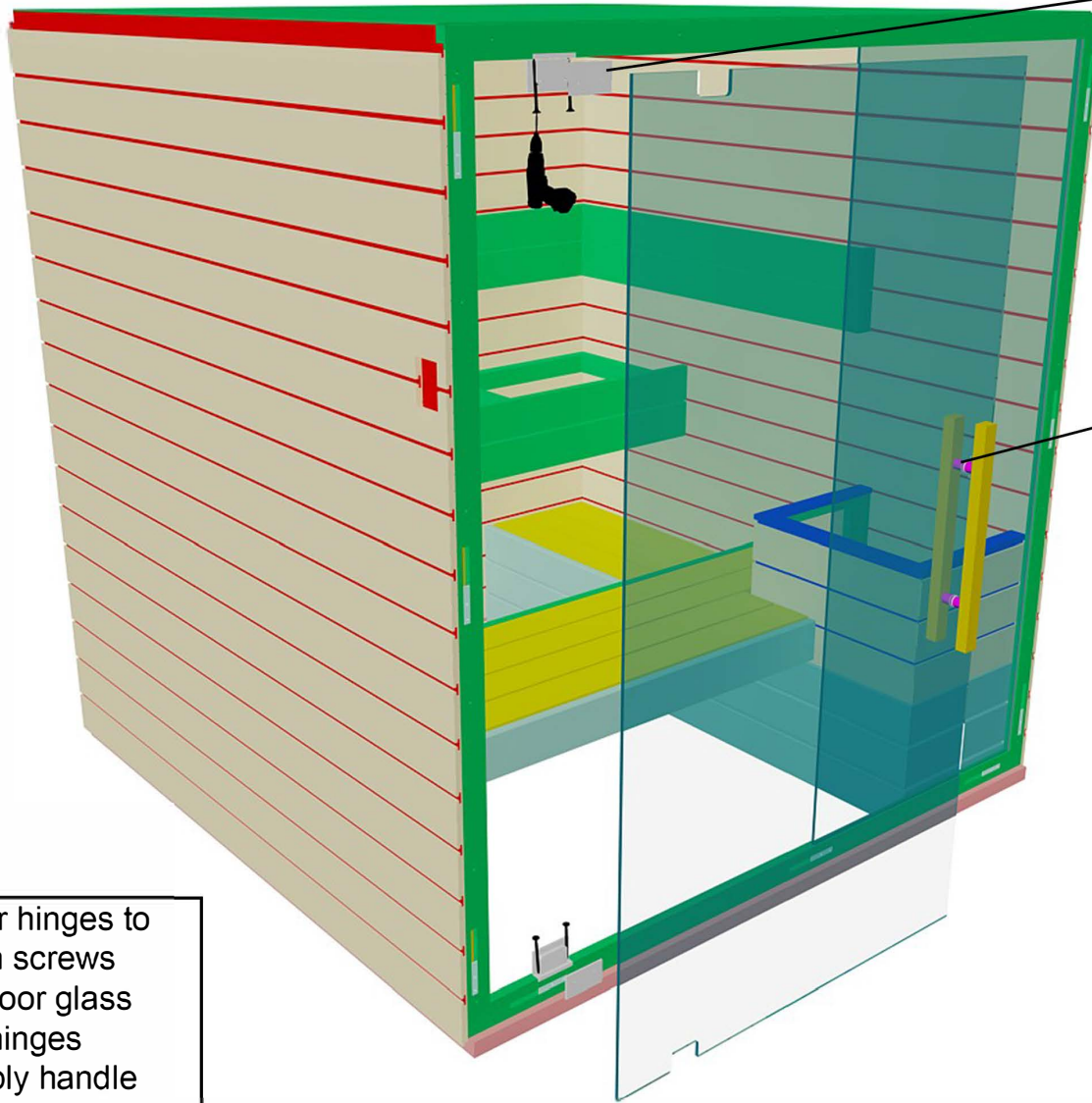

1. Fix door hinges to frame with screws
2. Place door glass between hinges
3. Assemble handle
3. Read hinge manual for regulation

16. Upper frame

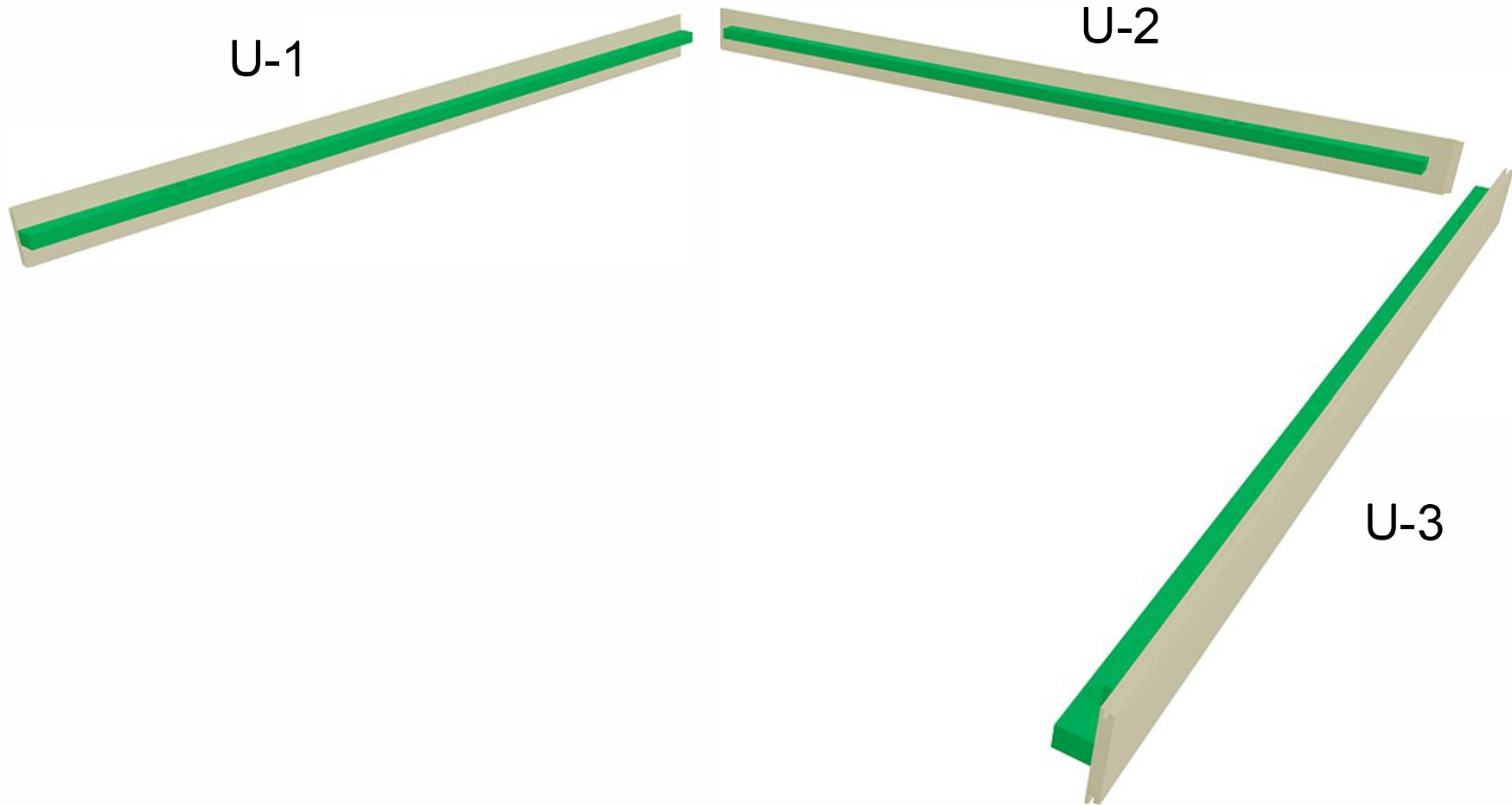

17. Fixing upper frame

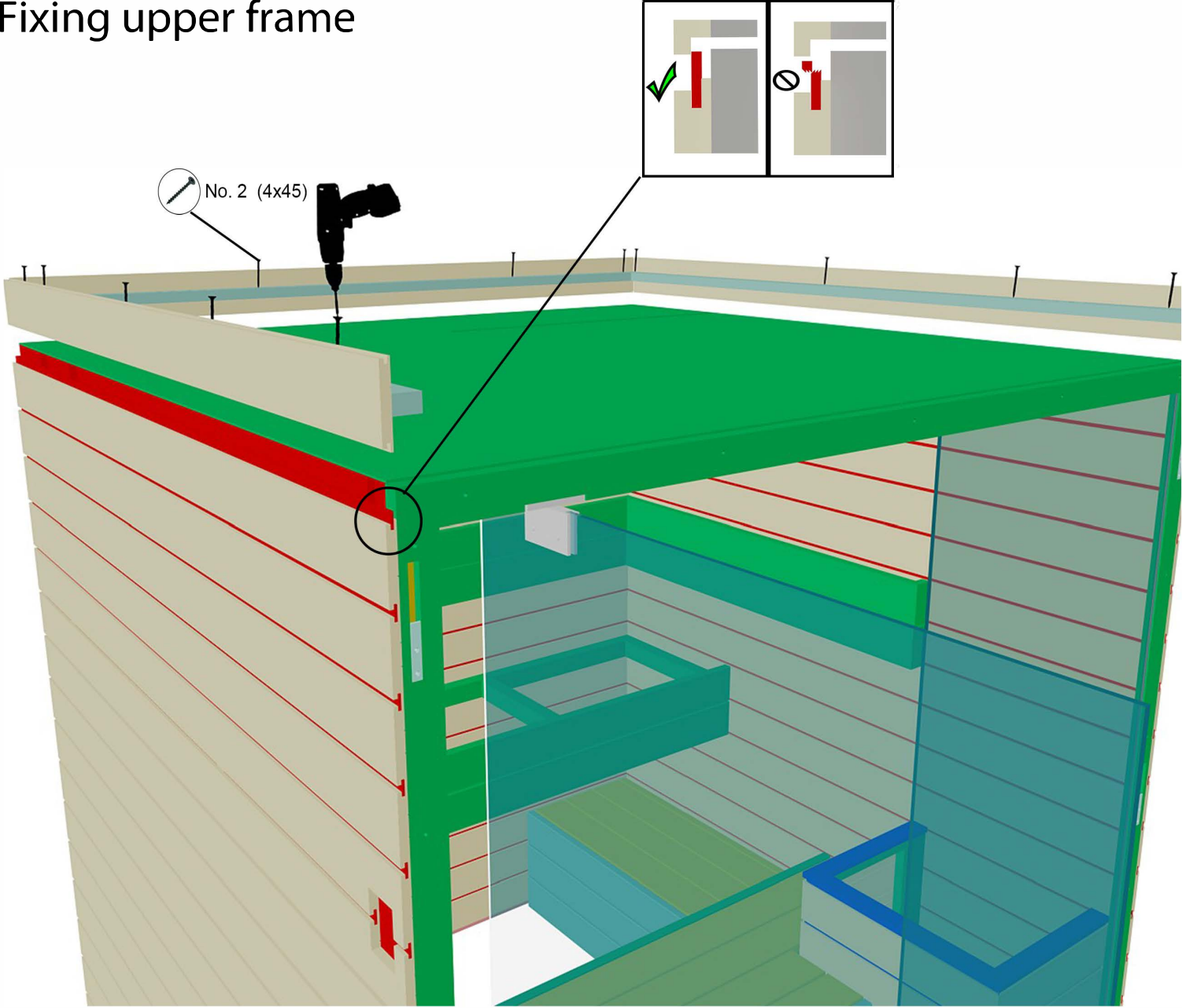

18. Front frame

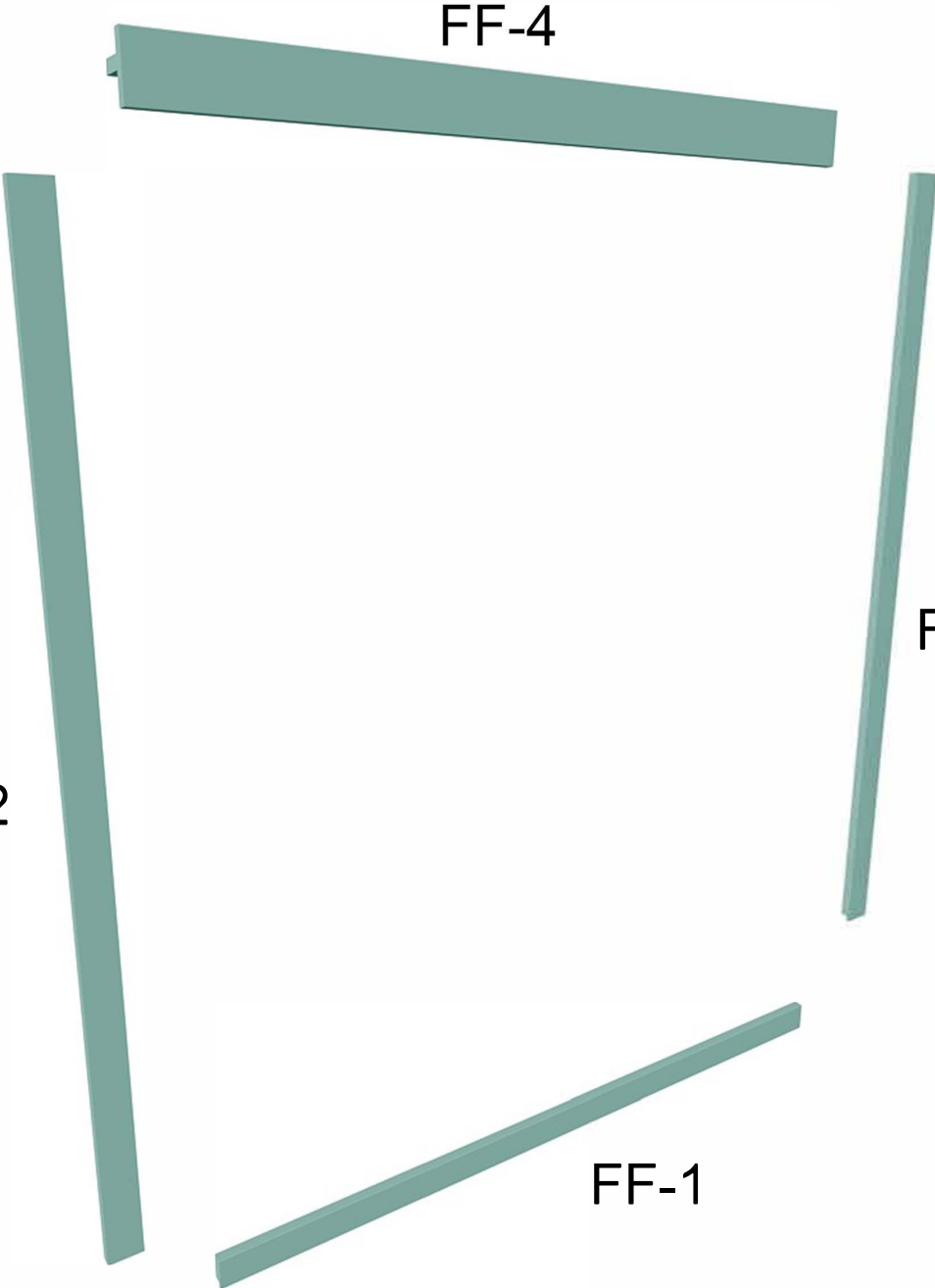

FF-4

FF-2

FF-3

FF-1

19. Fixing front frame

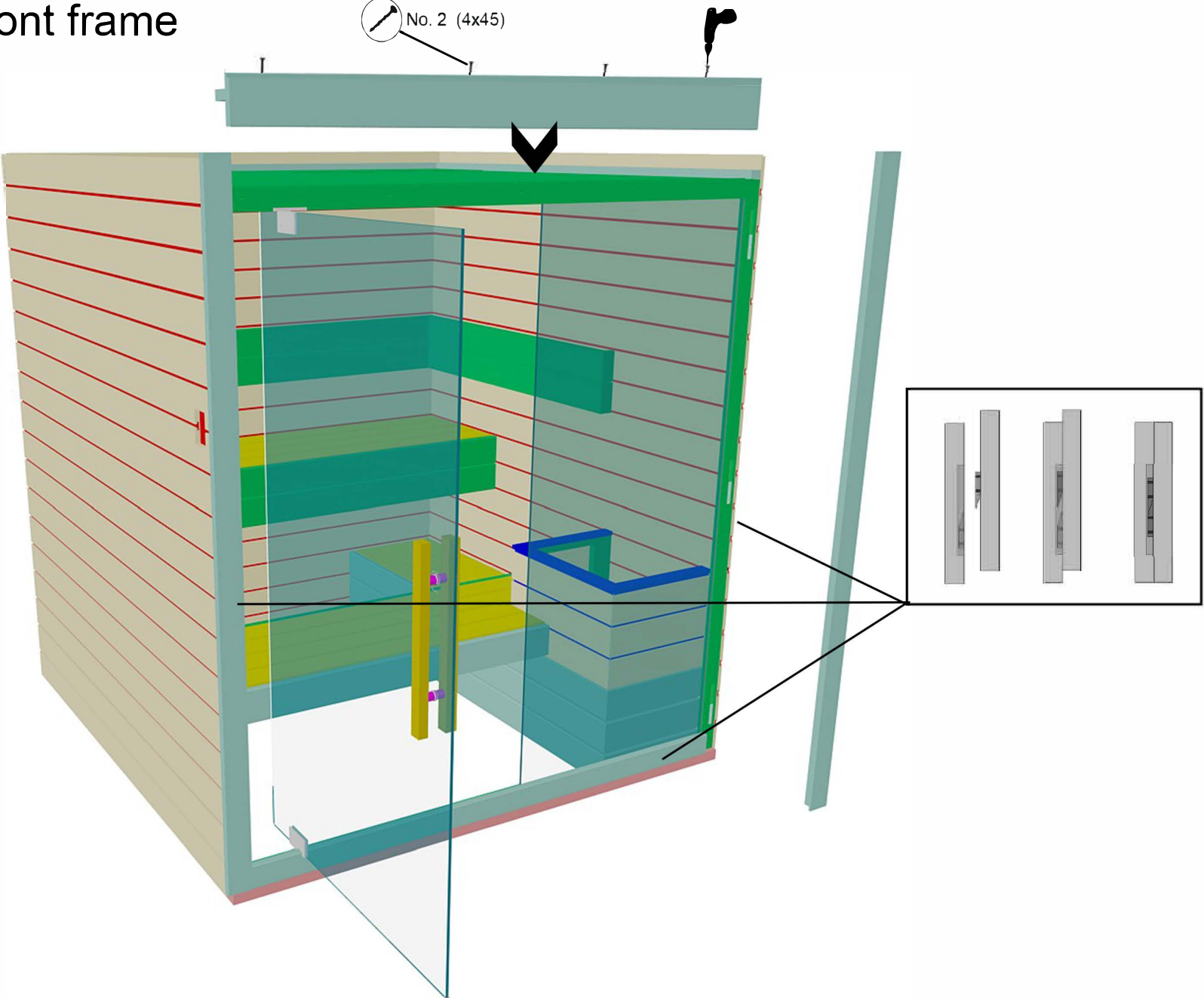

20. Floor frames

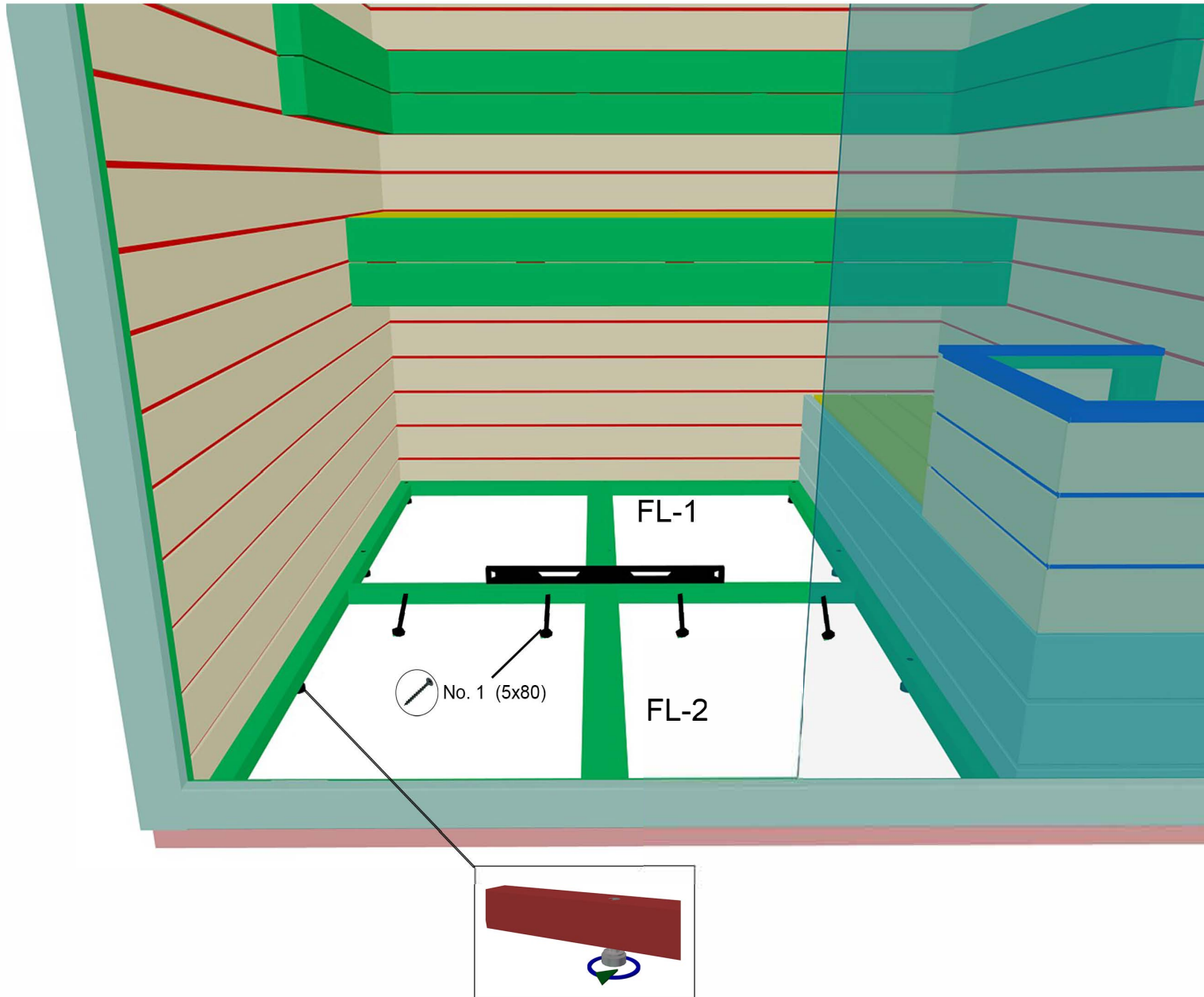

20.1 Floor grids

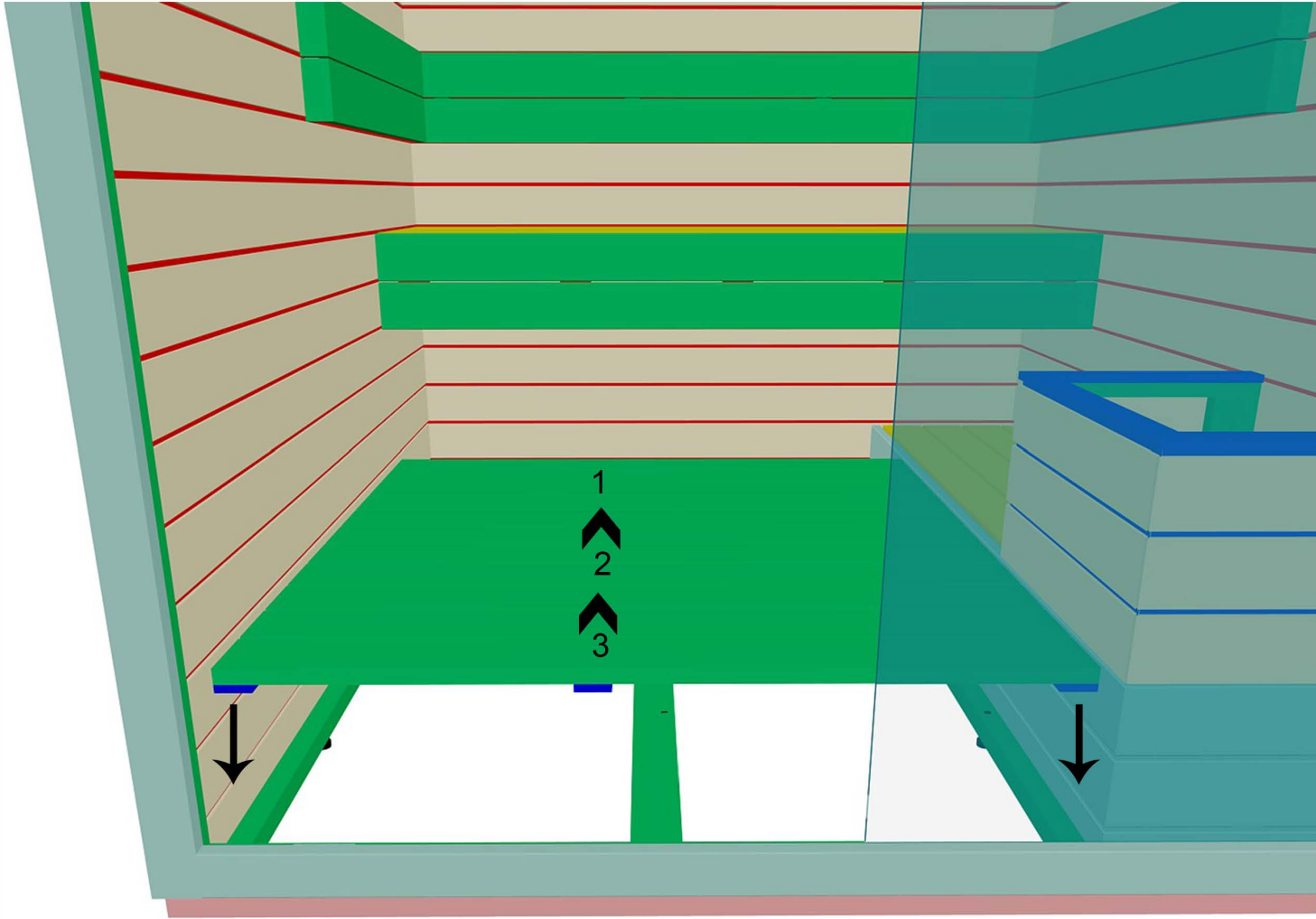

21. Wireing on ceilings

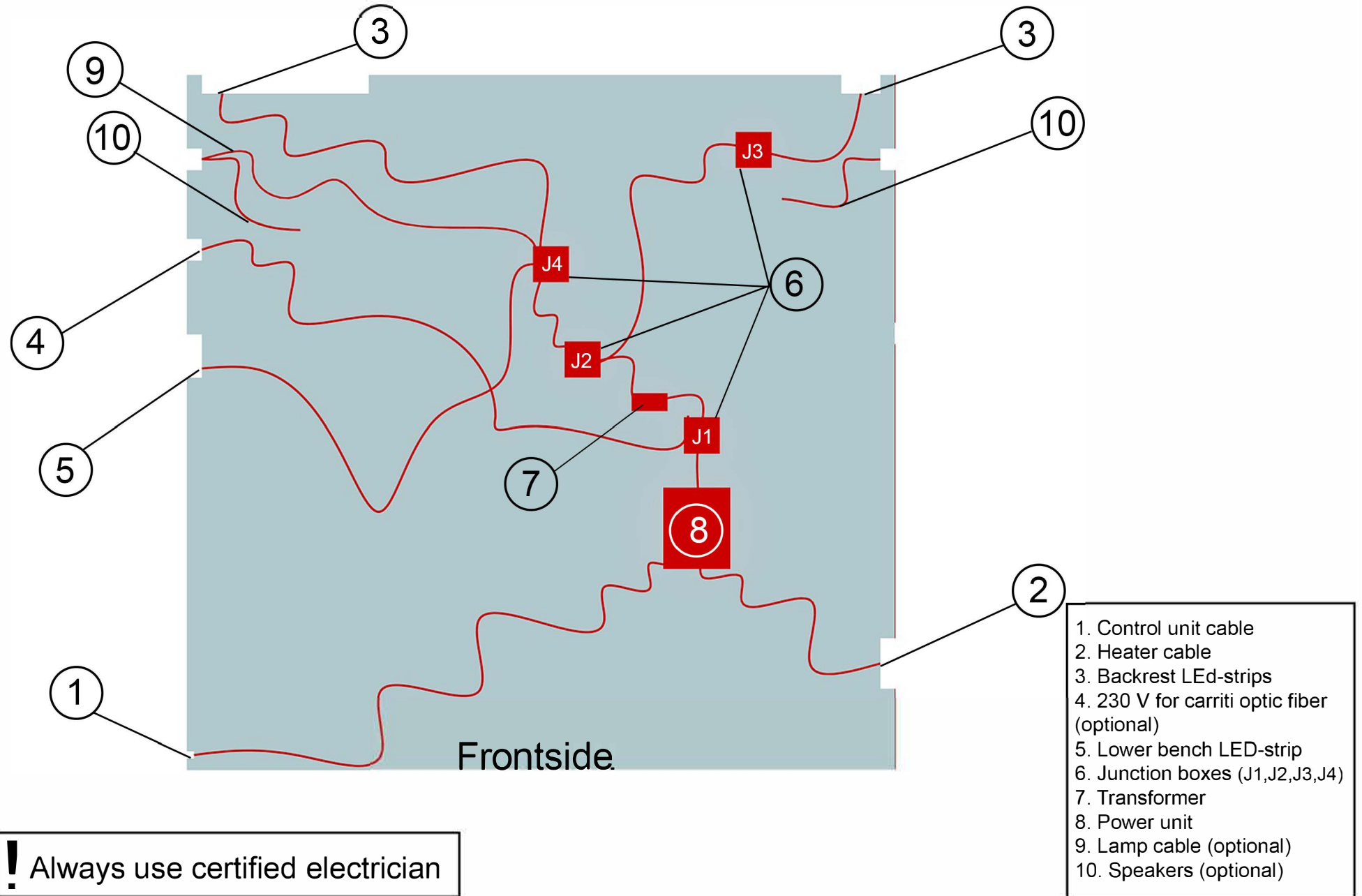

! Always use certified electrician